



**THERMOPLASTIC
DOORS AND
COMPONENTS**

CUSTOM PROGRAM



TABLE OF CONTENTS

01 DISCOVER OUR THERMOPLASTIC DOOR OPTIONS

Door models

04 SHAKER

14 SLAB

16 STANDARD

30 SPECIAL

34 COLORS AND FINISHES

36 COLOR OFFER

Customized touch

41 FRAME & MULLION DOORS

43 PANELS

44 MOULDINGS AND ACCESSORIES

Information

51 TECHNICAL SPECIFICATIONS

53 WARRANTY

DISCOVER OUR THERMOPLASTIC DOOR OPTIONS

1. SELECT THE PRODUCT

2XXX = Door

4XXX = Standard frame and mullion doors

6XXX = Special frame and mullion doors

3XXX = Drawer front

5XXX = Panels, mouldings and accessories

2. SELECT THE DESIGN

1 Square

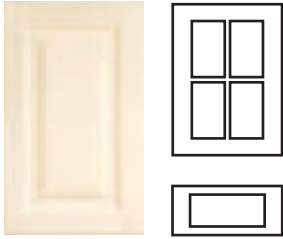

2 Arch

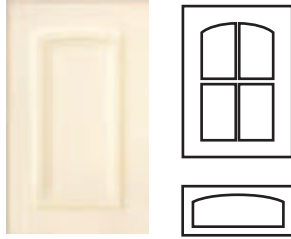

3 Cathedral

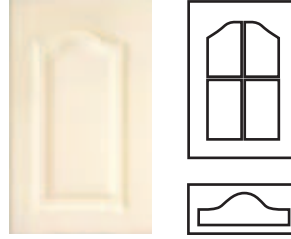

4 Half Circle

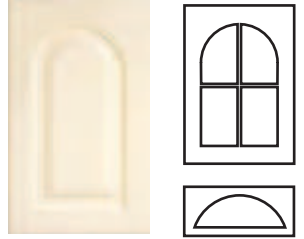

3. SELECT THE INTERIOR PROFILE



DISCOVER OUR THERMOPLASTIC DOOR OPTIONS

4. SELECT THE EXTERIOR PROFILE

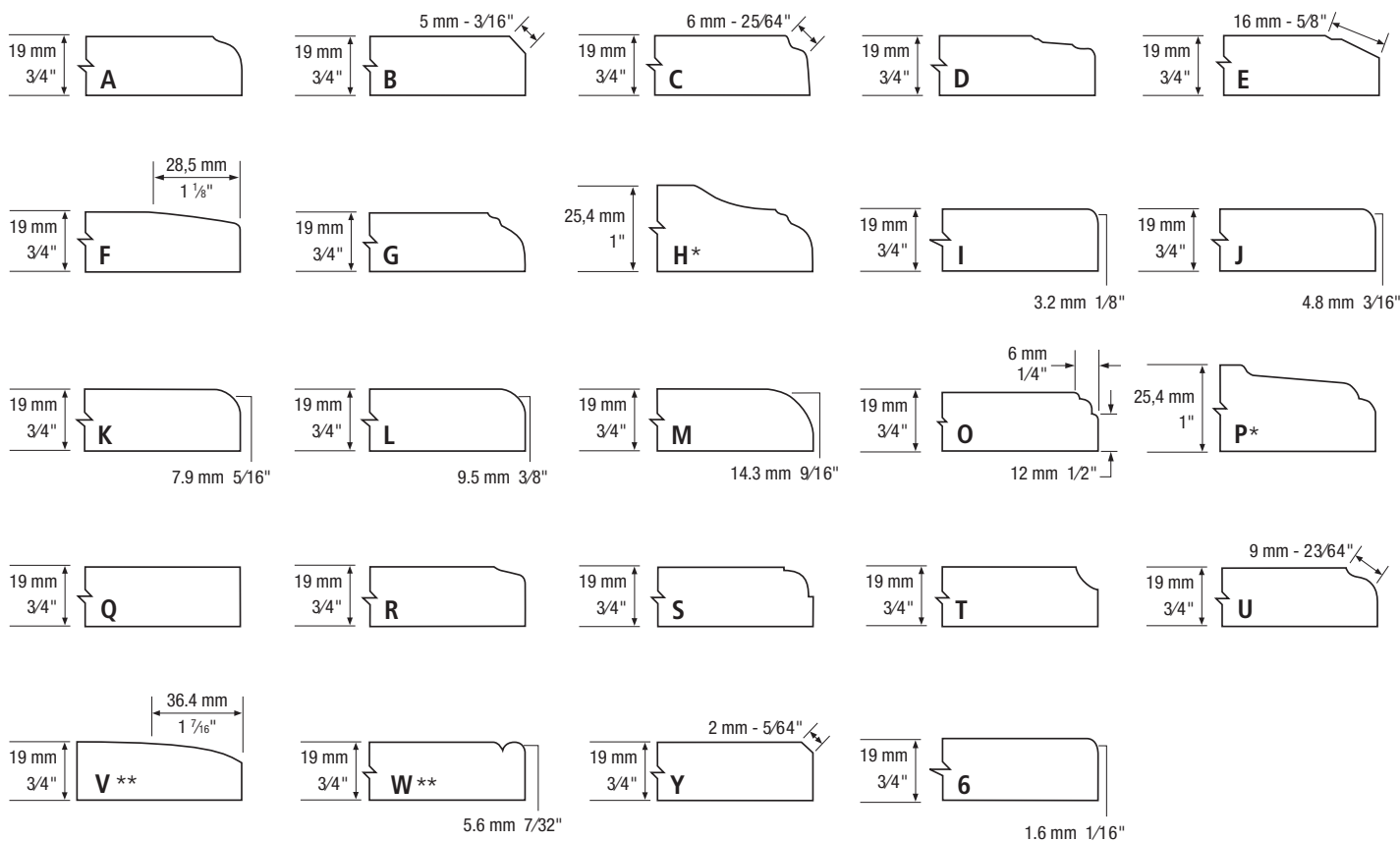

* Exterior profiles H and P available with MDF 1" only.

** Exterior profiles V and W available with an upcharge.

5. THE RESULT

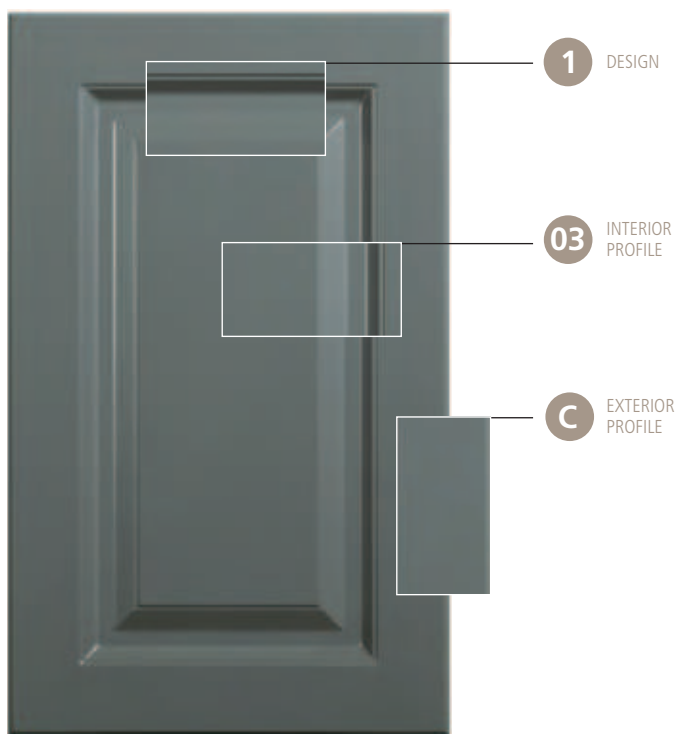

Model **2103**

Color: A661S

Vertical grooves optional. Details on page 33.



DOOR MODELS

- SHAKER
- SLAB
- STANDARD
- SPECIAL

SHAKER MODELS

OPTION:

- See availability of same color melamine back, pages 34-35.

SERIES 41 Category 6



Model **2141**
Color: R82S

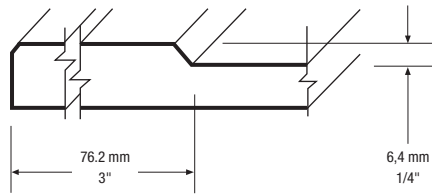

Model **3141**
Regular rails
38.1 mm
1 1/2"

Model **3141**
Reduced rails

Minimum dimensions

Doors and drawer fronts (Height x Width)

Model	mm	inches
2141/3141	177.8 x 177.8	7 x 7

Reduced rails drawer fronts (Height x Width)

Model	mm	inches
3141red	101.6 x 177.8	4 x 7

red = reduced rails
Default exterior profile: Y

SERIES 42 Category 6



Model **2142**

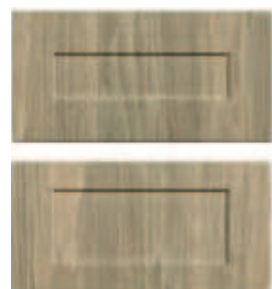
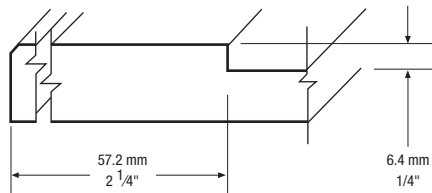

Model **3142**
Regular rails
38.1 mm
1 1/2"

Model **3142**
Reduced rails

Minimum dimensions

Doors and drawer fronts (Height x Width)

Model	mm	inches
2142/3142	139.7 x 139.7	5 1/2 x 5 1/2

Reduced rails drawer fronts (Height x Width)

Model	mm	inches
3142red	101.6 x 139.7	4 x 5 1/2

red = reduced rails
Default exterior profile: Y

STANDARD SPECIFICATIONS

- White melamine back
- The default woodgrain direction is vertical

- Shaker models drawer fronts are manufactured with regular rails (unless reduced rails are specified)
- Maximum door height: 2438 mm (96"), maximum door width: 1193 mm (47")

SERIES 51 Cat. 6 / 55 Cat. 6



Model **2151**

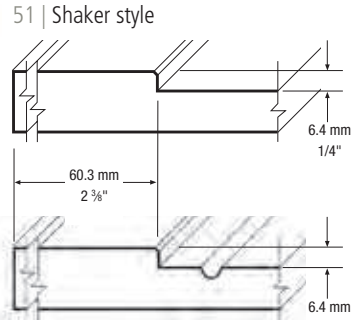

55 | Shaker style with grooves
The first groove starts at the center of the door



Model **3151**
Regular rails

25.4 mm
1"

Model **3151**
Reduced rails



Minimum dimensions

Doors and drawer fronts (Height x Width)

Model	mm	inches
2151/2155/3151/3155	146.0 x 146.0	5 3/4 x 5 3/4
2251/2255/3251/3255	161.0 x 146.0	6 11/32 x 5 3/4
2351/2355/3351/3355	186.0 x 200.6	7 11/32 x 7 29/32
2451/2455/3451/3455	$((W \div 2) + 99.5) \times 146.0$	$((W \div 2) + 3 15/16) \times 5 3/4$

Reduced rails drawer fronts (Height x Width)

Model	mm	inches
3151/3155red	76.2 x 146.0	3 x 5 3/4
3251/3255red	91.2 x 146.0	3 19/32 x 5 3/4
3351/3355red	116.2 x 200.6	4 9/16 x 7 7/8
3451/3455red	$((W \div 2) + 29.7) \times 146.0$	$((W \div 2) + 1 5/32) \times 5 3/4$

red = reduced rails / W = width
Default exterior profile: Y

Model **2155**



55

Category 6

SERIES 52 Cat. 6 / 56 Cat. 6



Model **2152**

Color: R82S

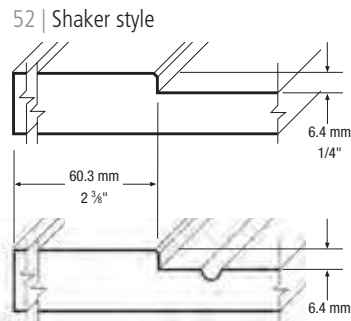

56 | Shaker style with grooves
The first groove starts at the center of the door



Model **3152**
Regular rails

25.4 mm
1"

Model **3152**
Reduced rails

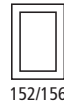

Minimum dimensions

Doors and drawer fronts (Height x Width)

Model	mm	inches
2152/2156/3152/3156	146.0 x 146.0	5 3/4 x 5 3/4
2252/2256/3252/3256	161.0 x 146.0	6 11/32 x 5 3/4
2352/2356/3352/3356	186.0 x 200.6	7 11/32 x 7 7/8
2452/2456/3452/3456	$((W \div 2) + 99.5) \times 146.0$	$((W \div 2) + 3 29/32) \times 5 3/4$

Reduced rails drawer fronts (Height x Width)

Model	mm	inches
3152/3156red	76.2 x 146.0	3 x 5 3/4
3252/3256red	91.2 x 146.0	3 19/32 x 5 3/4
3352/3356red	116.2 x 200.6	4 9/16 x 7 7/8
3452/3456red	$((W \div 2) + 29.7) \times 146.0$	$((W \div 2) + 1 5/32) \times 5 3/4$

red = reduced rails / W = width
Default exterior profile: Y

Model **2156**

Color: R82S



56

Category 6

SHAKER MODELS

OPTION:

- See availability of same color melamine back, pages 34-35.

SERIES 61 Cat. 6 / 65 Cat. 6



Model **2161**
Color: K85S

61 | Shaker style

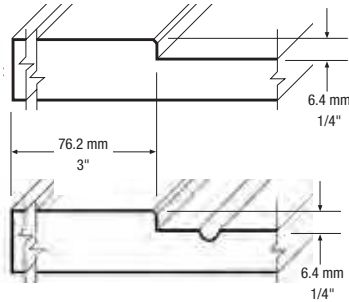

161/165



261/265

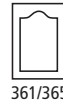

361/365



461/465

65 | Shaker style with grooves

The first groove starts at the center of the door



Model **3161**

Regular rails

25.4 mm
1"

Model **3161**

Reduced rails

Minimum dimensions

Doors and drawer fronts (Height x Width)

Model	mm	inches
2161/2165/3161/3165	177.8 x 177.8	7 x 7
2261/2265/3261/3265	192.8 x 177.8	7 19/32 x 7
2361/2365/3361/3365	217.8 x 232.4	8 19/32 x 9 5/32
2461/2465/3461/3465	$((W \div 2) + 115.4) \times 177.8$	$((W \div 2) + 4 9/16) \times 7$

Reduced rails drawer fronts (Height x Width)

Model	mm	inches
3161/3165red	76.2 x 177.8	3 x 7
3261/3265red	91.2 x 177.8	3 19/32 x 7
3361/3365red	116.2 x 232.4	4 19/32 x 9 5/32
3461/3465red	$((W \div 2) + 13.8) \times 177.8$	$((W \div 2) + 9/16) \times 7$

red = reduced rails / W = width

Default exterior profile: Y

Model **2165**

Color: K85S



65

Category 6

SERIES 62 Cat. 6 / 66 Cat. 6

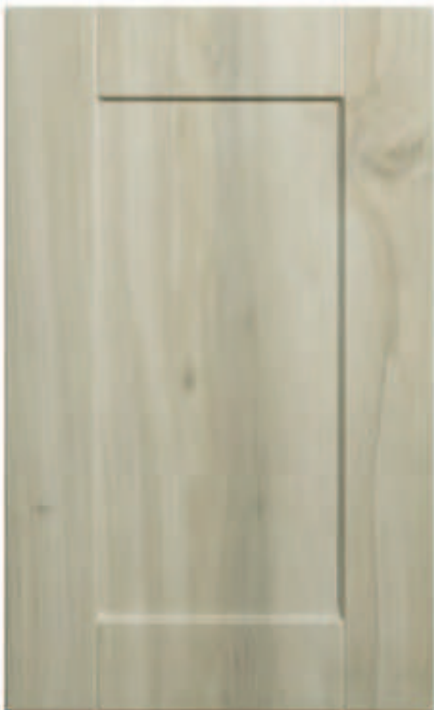

Model **2162**
Color: V66WT

62 | Shaker style

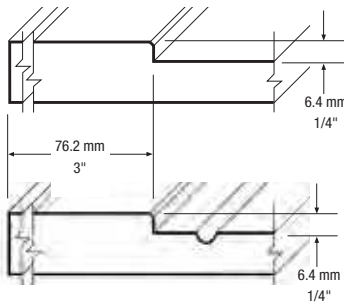

162/166



262/266

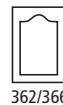

362/366



462/466

66 | Shaker style with grooves

The first groove starts at the center of the door



Model **3162**

Regular rails

25.4 mm
1"

Model **3162**

Reduced rails

Minimum dimensions

Doors and drawer fronts (Height x Width)

Model	mm	inches
2162/2166/3162/3166	177.8 x 177.8	7 x 7
2262/2266/3262/3266	192.8 x 177.8	7 19/32 x 7
2362/2366/3362/3366	217.8 x 232.4	8 19/32 x 9 5/32
2462/2466/3462/3466	$((W \div 2) + 115.4) \times 177.8$	$((W \div 2) + 4 9/16) \times 7$

Reduced rails drawer fronts (Height x Width)

Model	mm	inches
3162/3166red	76.2 x 177.8	3 x 7
3262/3266red	91.2 x 177.8	3 19/32 x 7
3362/3366red	116.2 x 232.4	4 19/32 x 9 5/32
3462/3466red	$((W \div 2) + 13.8) \times 177.8$	$((W \div 2) + 9/16) \times 7$

red = reduced rails / W = width

Default exterior profile: Y

Model **2166**

Color: V66WT



66

Category 6

STANDARD SPECIFICATIONS

- White melamine back
- The default woodgrain direction is vertical
- Shaker models drawer fronts are manufactured with regular rails (unless reduced rails are specified)
- Maximum door height: 2438 mm (96"), maximum door width: 1193 mm (47")

SERIES 70 Category 6



Model **2170**
Color: V66WT

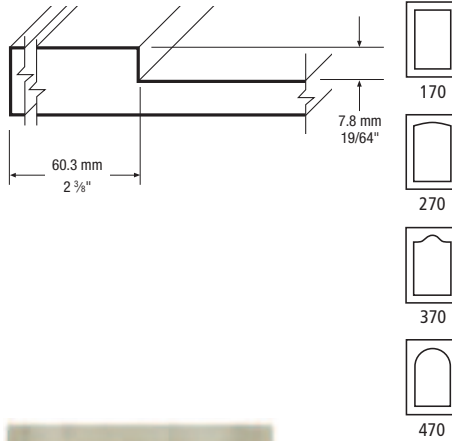

Model **3170**
Regular rails
25.4 mm
1"

Model **3170**
Reduced rails

Minimum dimensions

Doors and drawer fronts (Height x Width)

Model	mm	inches
2170/3170	146.0 x 146.0	5 3/4 x 5 3/4
2270/3270	161.0 x 146.0	6 11/32 x 5 3/4
2370/3370	186.0 x 200.6	7 11/32 x 7 29/32
2470/3470	$((W \div 2) + 99.5) \times 146.0$	$((W \div 2) + 3 31/32) \times 5 3/4$

Reduced rails drawer fronts (Height x Width)

Model	mm	inches
3170red	76.2 x 146.0	3 x 5 3/4
3270red	91.2 x 146.0	3 19/32 x 5 3/4
3370red	116.2 x 200.6	4 9/16 x 7 7/8
3470red	$((W \div 2) + 29.7) \times 146.0$	$((W \div 2) + 1 11/64) \times 5 3/4$

red = reduced rails / W = width
Default exterior profile: B

SERIES 71 Category 6



Model **2171**
Color: K85S

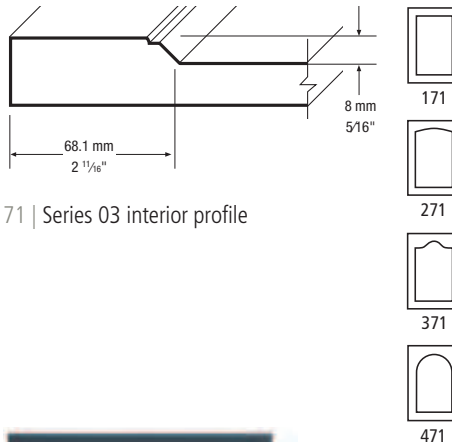

71 | Series 03 interior profile



Model **3171**
Regular rails
38.3 mm
1 33/64"

Model **3171**
Reduced rails

Minimum dimensions

Doors and drawer fronts (Height x Width)

Model	mm	inches
2171/3171	161.6 x 161.6	6 3/8 x 6 3/8
2271/3271	176.6 x 161.6	6 31/32 x 6 3/8
2371/3371	201.6 x 201.8	7 15/16 x 7 31/32
2471/3471	$((W \div 2) + 82.5) \times 161.6$	$((W \div 2) + 3 1/4) \times 6 3/8$

Reduced rails drawer fronts (Height x Width)

Model	mm	inches
3171red	102.0 x 161.6	4 1/64 x 6 3/8
3271red	117.0 x 161.6	4 39/64 x 6 3/8
3371red	142.0 x 201.8	5 19/32 x 7 31/32
3471red	$((W \div 2) + 22.9) \times 161.6$	$((W \div 2) + 29/32) \times 6 3/8$

red = reduced rails / W = width
Default exterior profile: B

SHAKER MODELS

OPTION:

- See availability of same color melamine back, pages 34-35.

SERIES 72 Category 6



Model **2172**
Color: A661S

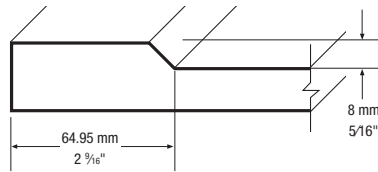

72 | Series 09 interior profile



Model **3172**
Regular rails

31.9 mm
1 1/4"

Model **3172**
Reduced rails

Minimum dimensions

Doors and drawer fronts (Height x Width)

Model	mm	inches
2172/3172	155.3 x 155.3	6 1/8 x 6 1/8
2272/3272	170.3 x 155.3	6 23/32 x 6 1/8
2372/3372	195.3 x 193.9	7 23/32 x 7 21/32
2472/3472	$((W \div 2) + 79.8) \times 155.3$	$((W \div 2) + 3 1/8) \times 6 1/8$

Reduced rails drawer fronts (Height x Width)

Model	mm	inches
3172red	91.3 x 155.3	3 5/8 x 6 1/8
3272red	106.3 x 155.3	4 3/16 x 6 1/8
3372red	131.3 x 193.9	5 3/16 x 7 21/32
3472red	$((W \div 2) + 15.4) \times 155.3$	$((W \div 2) + 39/64) \times 6 1/8$

red = reduced rails / W = width
Default exterior profile: B

SERIES 77 Category 6



Model **2177**
Color: A4WT

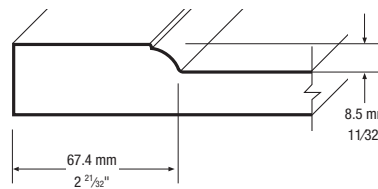

77 | Series 83 interior profile



Model **3177**
Regular rails

36.4 mm
1 7/16"

Model **3177**
Reduced rails

Minimum dimensions

Doors and drawer fronts (Height x Width)

Model	mm	inches
2177/3177	179.8 x 179.8	7 3/32 x 7 3/32
2277/3277	194.8 x 179.8	7 11/16 x 7 3/32
2377/3377	219.8 x 214.8	8 21/32 x 8 15/32
2477/3477	$((W \div 2) + 112.5) \times 179.8$	$((W \div 2) + 4 7/16) \times 7 3/32$

Reduced rails drawer fronts (Height x Width)

Model	mm	inches
3177red	116.6 x 179.8	4 19/32 x 7 3/32
3277red	131.6 x 179.8	5 3/16 x 7 3/32
3377red	156.6 x 214.8	6 3/16 x 8 15/32
3477red	$((W \div 2) + 49.3) \times 179.8$	$((W \div 2) + 1 31/32) \times 7 3/32$

red = reduced rails / W = width
Default exterior profile: C

STANDARD SPECIFICATIONS

- White melamine back
- The default woodgrain direction is vertical

- Shaker models drawer fronts are manufactured with regular rails (unless reduced rails are specified)
- Maximum door height: 2438 mm (96"), maximum door width: 1193 mm (47")

SERIES 78 Category 6



Model **2178**
Color: A4WT

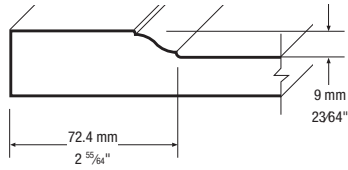

78 | Series 85 interior profile



Model **3178**
Regular rails

Model **3178**
Reduced rails



Minimum dimensions

Doors and drawer fronts (Height x Width)

Model	mm	inches
2178/3178	189.8 x 189.8	7 1/2 x 7 1/2
2278/3278	204.8 x 189.8	8 3/32 x 7 1/2
2378/3378	229.8 x 224.8	9 1/16 x 8 7/8
2478/3478	$(W \div 2) + 117.5$ x 189.8	$((W \div 2) + 4 \frac{21}{32})$ x 7 1/2

Reduced rails drawer fronts (Height x Width)

Model	mm	inches
3178red	126.6 x 189.8	5 x 7 1/2
3278red	141.6 x 189.8	5 19/32 x 7 1/2
3378red	166.6 x 224.8	6 9/16 x 8 7/8
3478red	$(W \div 2) + 54.3$ x 189.8	$((W \div 2) + 2 \frac{5}{32})$ x 7 1/2

red = reduced rails / W = width
Default exterior profile: C

SERIES 79 Category 6



Model **2179**
Color: A661S

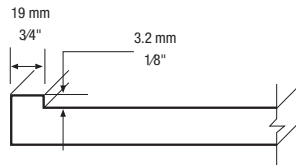

Model **3179**
Regular rails

Minimum dimensions

Doors and drawer fronts (Height x Width)

Model	mm	inches
2179/3179	76.2 x 76.2	3 x 3

W = width
Default exterior profile: Q
Available exterior profiles: I, J, Q, Y and 6

Serie 79 is not available in colors C35S and R49L
Mullion Door: model 4101 only

SHAKER MODELS

OPTION:

- See availability of same color melamine back, pages 34-35.

SERIES 80 Category 6



Model **2180**
Color: K464WT

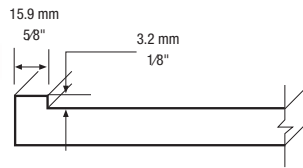

Model **3180**
Regular rails

Minimum dimensions

Doors and drawer fronts (Height x Width)

Model	mm	inches
2180/3180	76.2 x 76.2	3 x 3

W = width

Default exterior profile: Q

Available exterior profiles: I, J, Q, Y and 6

Series 80 is not available in colors C355 & R49L

Mullion Door : model 4101 only

SERIES 942 Category 6



Model **2942**
Color: K257S

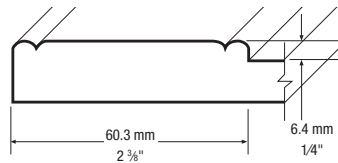

Model **3942**
Regular rails



25.4 mm
1"

Model **3942**
Reduced rails

Minimum dimensions

Doors and drawer fronts (Height x Width)

Model	mm	inches
2942/3942	146.0 x 146.0	5 3/4 x 5 3/4

Reduced rails drawer fronts (Height x Width)

Model	mm	inches
3942red	76.2 x 146.0	3 x 5 3/4

red = reduced rails

Default exterior profile: W

STANDARD SPECIFICATIONS

- White melamine back
- The default woodgrain direction is vertical

- Shaker models drawer fronts are manufactured with regular rails (unless reduced rails are specified)
- Maximum door height: 2438 mm (96"), maximum door width: 1193 mm (47")

SERIES 64 Category 4



Model **2164**
Color: K257S

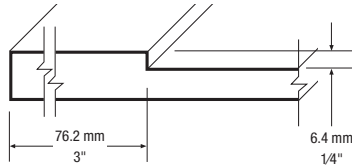

Model **3164**
Regular rails

25.4 mm
1"



Model **3164**
Reduced rails

Minimum dimensions

Doors and drawer fronts (Height x Width)

Model	mm	inches
2164/3164	177.8 x 177.8	7 x 7

Reduced rails drawer fronts (Height x Width)

Model	mm	inches
3164red	76.2 x 177.8	3 x 7

red = reduced rails
Default exterior profile: Y

SERIES 67 Category 4



Model **2167**
Color: K464WT

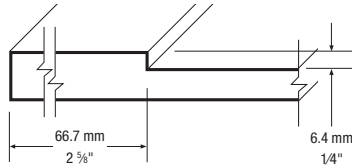

Model **3167**
Regular rails

25.4 mm
1"



Model **3167**
Reduced rails

Minimum dimensions

Doors and drawer fronts (Height x Width)

Model	mm	inches
2167/3167	158.8 x 158.8	6 1/4 x 6 1/4

Reduced rails drawer fronts (Height x Width)

Model	mm	inches
3167red	76.2 x 158.8	3 x 6 1/4

red = reduced rails
Default exterior profile: Y

SHAKER MODELS

OPTION:

- See availability of same color melamine back, pages 34-35.

SERIES 764 Category 5



Model **2764**
Color: R82S

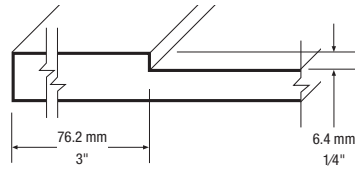

Model **3764**
Regular rails

25.4 mm
1"

Model **3764**
Reduced rails

Minimum dimensions

Doors and drawer fronts (Height x Width)

Model	mm	inches
2764/3764	177.8 x 177.8	7 x 7

Reduced rails drawer fronts (Height x Width)

Model	mm	inches
3764red	76.2 x 177.8	3 x 7

red = reduced rails
Default exterior profile: Y

SERIES 767 Category 5



Model **2767**

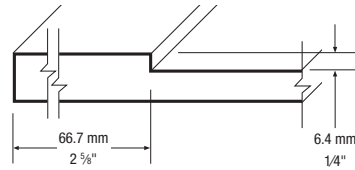

Model **3767**
Regular rails

25.4 mm
1"

Model **3767**
Reduced rails

Minimum dimensions

Doors and drawer fronts (Height x Width)

Model	mm	inches
2767/3767	158.8 x 158.8	6 1/4 x 6 1/4

Reduced rails drawer fronts (Height x Width)

Model	mm	inches
3767red	76.2 x 158.8	3 x 6 1/4

red = reduced rails
Default exterior profile: Y

STANDARD SPECIFICATIONS

- White melamine back
- The default woodgrain direction is vertical
- Shaker drawer fronts are manufactured with regular rails (unless reduced rails are specified)
- Maximum door height: 2438 mm (96"), maximum door width: 1193 mm (47")

SERIES 945 Category 7



Model **2945**

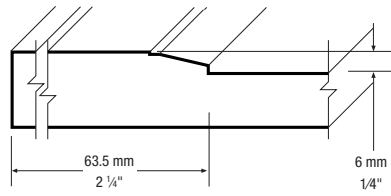

Model **3945**

Regular rails

38.1 mm
1 1/2"



Model **3945**

Reduced rails

Minimum dimensions

Doors and drawer fronts (Height x Width)

Model	mm	inches
2945/3945	152.4 x 152.4	6 x 6

Reduced rails drawer fronts (Height x Width)

Model	mm	inches
3945red	101.6 x 152.4	4 x 6

red = reduced rails

Default exterior profile: Y



C35S - White - Satin

SLAB MODELS

OPTION:

- See availability of same color melamine back, pages 34-35.

SERIES 00 Category 1

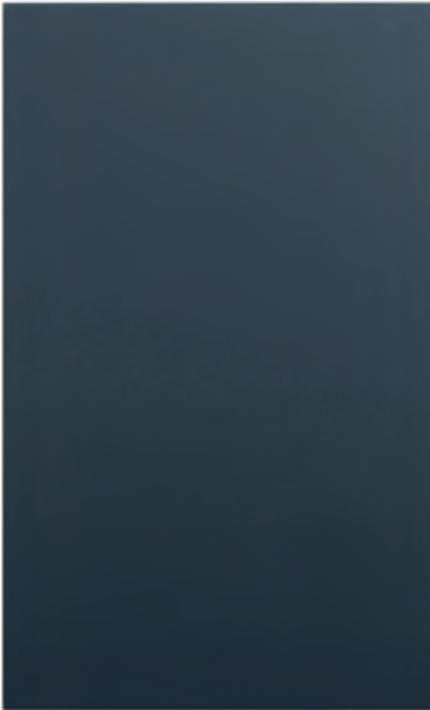

Model **2000**
Color: K85S

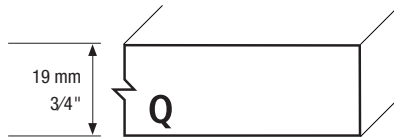

Model **3000**

Minimum dimensions for series 00 vary according to the exterior profile selected:

Doors and drawer fronts (Height x Width)

Model	Exterior profile	mm	inches
2000/3000	A, B, C, G, I, J, K, L, M, O, Q, R, S, T, U, Y, 6	38.1 x 38.1	1 1/2 x 1 1/2
2000/3000	D, E, W	50.8 x 50.8	2 x 2
2000/3000	F, V	76.2 x 76.2	3 x 3
2000/3000	H	82.6 x 82.6	3 1/4 x 3 1/4
2000/3000	P	90.5 x 90.5	3 9/16 x 3 9/16

Minimum charge of 0.19 sq.m. (2 sq.ft.) for thermoplastic fillers whose height or width is less than 76.2 mm (3") and whose length is greater than 1828 mm (72").

Frame and mullion doors not available in this model.

SERIES 00 Category 1



Model **2000**
Color: V66WT

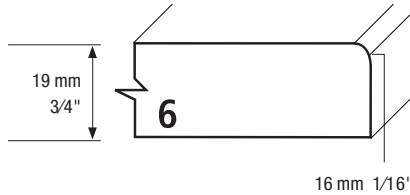

Model **3000**

Minimum dimensions for series 00 vary according to the exterior profile selected:

Doors and drawer fronts (Height x Width)

Model	Exterior profile	mm	inches
2000/3000	A, B, C, G, I, J, K, L, M, O, Q, R, S, T, U, Y, 6	38.1 x 38.1	1 1/2 x 1 1/2
2000/3000	D, E, W	50.8 x 50.8	2 x 2
2000/3000	F, V	76.2 x 76.2	3 x 3
2000/3000	H	82.6 x 82.6	3 1/4 x 3 1/4
2000/3000	P	90.5 x 90.5	3 9/16 x 3 9/16

Minimum charge of 0.19 sq.m. (2 sq.ft.) for thermoplastic fillers whose height or width is less than 76.2 mm (3") and whose length is greater than 1828 mm (72").

Frame and mullion doors not available in this model.

STANDARD SPECIFICATIONS

- White melamine back
- The default woodgrain direction is vertical

- Maximum door height: 2438 mm (96"), maximum door width: 1193 mm (47")

SERIES 00 Category 1



Model **2000**
Color: V66WT

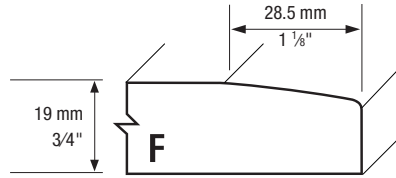

Model **3000**

Minimum dimensions for series 00 vary according to the exterior profile selected:

Doors and drawer fronts (Height x Width)

Model	Exterior profile	mm	inches
2000/3000	A, B, C, G, I, J, K, L, M, O, Q, R, S, T, U, Y, 6	38.1 x 38.1	1 1/2 x 1 1/2
2000/3000	D, E, W	50.8 x 50.8	2 x 2
2000/3000	F, V	76.2 x 76.2	3 x 3
2000/3000	H	82.6 x 82.6	3 1/4 x 3 1/4
2000/3000	P	90.5 x 90.5	3 9/16 x 3 9/16

Minimum charge of 0.19 sq.m. (2 sq.ft.) for thermoplastic fillers whose height or width is less than 76.2 mm (3") and whose length is greater than 1828 mm (72").

Frame and mullion doors not available in this model.

SERIES 00 Category 2



Model **2000**
Color: K85S

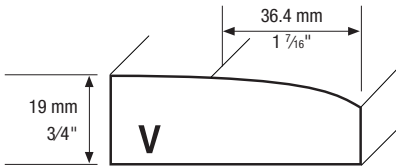

Model **3000**

Minimum dimensions for series 00 vary according to the exterior profile selected:

Doors and drawer fronts (Height x Width)

Model	Exterior profile	mm	inches
2000/3000	A, B, C, G, I, J, K, L, M, O, Q, R, S, T, U, Y, 6	38.1 x 38.1	1 1/2 x 1 1/2
2000/3000	D, E, W	50.8 x 50.8	2 x 2
2000/3000	F, V	76.2 x 76.2	3 x 3
2000/3000	H	82.6 x 82.6	3 1/4 x 3 1/4
2000/3000	P	90.5 x 90.5	3 9/16 x 3 9/16

Minimum charge of 0.19 sq.m. (2 sq.ft.) for thermoplastic fillers whose height or width is less than 76.2 mm (3") and whose length is greater than 1828 mm (72").

Frame and mullion doors not available in this model.

STANDARD MODELS

OPTIONS:

- See availability of same color melamine back, pages 34-35.
- For regular rails drawer fronts, order as a door.

SERIES 03 Category 4



Model **2103**
Color: A661S

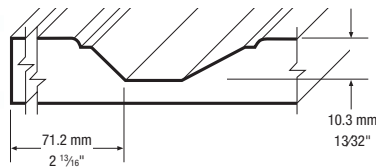

Minimum dimensions

Doors (Height x Width)

Model	mm	inches
2103	225.0 x 225.0	8 7/8 x 8 7/8
2203	240.0 x 225.0	9 15/32 x 8 7/8
2303	265.0 x 225.0	10 7/16 x 8 7/8
2403	$((W \div 2) + 82.5) \times 225.0$	$((W \div 2) + 3 1/4) \times 8 7/8$

Drawer fronts (Height x Width)

Model	mm	inches
3103	146.4 x 225.0	5 25/32 x 8 7/8
3203	161.4 x 225.0	6 3/8 x 8 7/8
3303	186.4 x 225.0	7 11/32 x 8 7/8
3403	$((W \div 2) + 3.9) \times 225.0$	$((W \div 2) + 5/32) \times 8 7/8$

W = width
Default exterior profile: B

SERIES 27 Category 4



Model **2127**
Color: A4WT

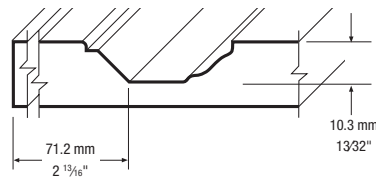

Minimum dimensions

Doors (Height x Width)

Model	mm	inches
2127	208.4 x 208.4	8 7/32 x 8 7/32
2227	223.4 x 208.4	8 13/16 x 8 7/32
2327	248.4 x 208.4	9 25/32 x 8 7/32
2427	$((W \div 2) + 81.2) \times 208.4$	$((W \div 2) + 3 7/32) \times 8 7/32$

Drawer fronts (Height x Width)

Model	mm	inches
3127	129.8 x 208.4	5 1/8 x 8 7/32
3227	144.8 x 208.4	5 23/32 x 8 7/32
3327	169.8 x 208.4	6 11/16 x 8 7/32
3427	$((W \div 2) + 2.6) \times 208.4$	$((W \div 2) + 1/8) \times 8 7/32$

W = width
Default exterior profile: A

STANDARD SPECIFICATIONS

- White melamine back
- The default woodgrain direction is vertical

- Standard models drawer fronts are manufactured with reduced rails (unless regular rails are specified)
- Maximum door height: 2438 mm (96"), maximum door width: 1193 mm (47")

SERIES 49 Category 4



Model **2149**
Color: A4WT

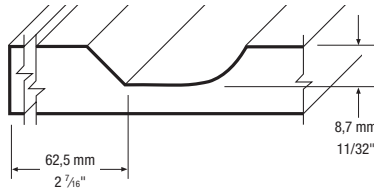

149



249



349



449

Minimum dimensions

Doors (Height x Width)

Model	mm	inches
2149	195.6 x 195.6	7 ²³ / ₃₂ x 7 ²³ / ₃₂
2249	210.6 x 195.6	8 ⁵ / ₁₆ x 7 ²³ / ₃₂
2349	238.6 x 220.0	9 ¹³ / ₃₂ x 8 ¹¹ / ₁₆
2449	((W÷2) + 77) x 195.6	((W÷2) + 3 ¹ / ₁₆) x 7 ²³ / ₃₂

Drawer fronts (Height x Width)

Model	mm	inches
3149	139.6 x 195.6	5 ¹ / ₂ x 7 ²³ / ₃₂
3249	154.6 x 195.6	6 ³ / ₃₂ x 7 ²³ / ₃₂
3349	185.6 x 220.0	7 ⁵ / ₁₆ x 8 ¹¹ / ₁₆
3449	((W÷2) + 21) x 195.6	((W÷2) + ²⁷ / ₃₂) x 7 ²³ / ₃₂

W = width
Default exterior profile: C



Model **3149**
Reduced rails

SERIES 50 Cat. 2 / 40 Cat. 2



Model **2150**
Color: A661S

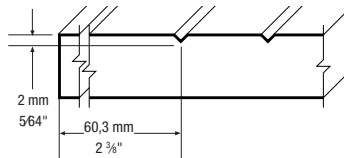

50 | Standard style with grooves

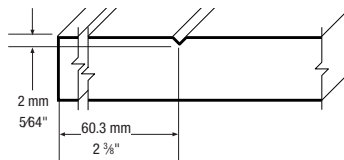

40 | Standard style



150



250



350



450



Model **3150**
Regular rails



Model **3150**
Reduced rails

Minimum dimensions

Doors and drawer fronts (Height x Width)

Model	mm	inches
2150/2140/3150/3140	146.0 x 146.0	5 ³ / ₄ x 5 ³ / ₄
2250/2240/3250/3240	161.0 x 146.0	6 ¹¹ / ₃₂ x 5 ³ / ₄
2350/2340/3350/3340	186.0 x 200.6	7 ¹¹ / ₃₂ x 7 ²⁹ / ₃₂
2450/2440/3450/3440	((W÷2) + 60.4) x 146.0	((W÷2) + 2 ¹³ / ₃₂) x 5 ³ / ₄

Reduced rails drawer fronts (Height x Width)

Model	mm	inches
3150/3140red	76.2 x 146.0	3 x 5 ³ / ₄
3250/3240red	91.2 x 146.0	3 ¹⁹ / ₃₂ x 5 ³ / ₄
3350/3340red	116.2 x 200.6	4 ¹⁹ / ₃₂ x 7 ²⁹ / ₃₂
3450/3440red	((W÷2) - 9.4) x 146.0	((W÷2) - ³ / ₈) x 5 ³ / ₄

red = reduced rails / W = width
Default exterior profile: Q
Not available with exterior profiles D, F, H, P, V and W.

Series 40 and 50 drawer fronts are manufactured with regular rails. If reduced rails drawer fronts are required, it must be specify when ordering.

Model **2140**
Color: A661S



40

Category 2

STANDARD MODELS

OPTIONS:

- See availability of same color melamine back, pages 34-35.
- For regular rails drawer fronts, order as a door.

SERIES 73 Category 3



Model **2173**
Color: K464WT

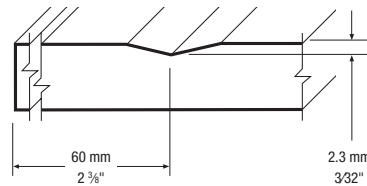

Model **3173**
Reduced rails

Minimum dimensions

Doors (Height x Width)

Model	mm	inches
2173	153.7 x 153.7	6 1/16 x 6 1/16
2273	168.7 x 153.7	6 21/32 x 6 1/16
2373	193.7 x 200.0	7 21/32 x 7 7/8
2473	$((W \div 2) + 60.1) \times 153.7$	$((W \div 2) + 2 \frac{3}{8}) \times 6 \frac{1}{16}$

Drawer fronts (Height x Width)

Model	mm	inches
3173	93.7 x 153.7	3 23/32 x 6 1/16
3273	108.7 x 153.7	4 9/32 x 6 1/16
3373	133.7 x 200.0	5 9/32 x 7 7/8
3473	$((W \div 2) + 12.4) \times 153.7$	$((W \div 2) + 1/2) \times 6 \frac{1}{16}$

W = width
Default exterior profile: B

SERIES 76 Category 4



Model **2176**
Color: K257S

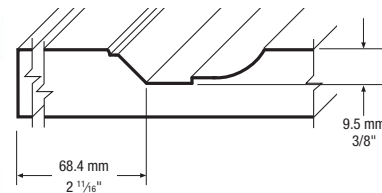

Model **3176**
Reduced rails

Minimum dimensions

Doors (Height x Width)

Model	mm	inches
2176	216.1 x 216.1	8 17/32 x 8 17/32
2276	231.1 x 216.1	9 1/8 x 8 17/32
2376	256.1 x 216.1	10 3/32 x 8 17/32
2476	$((W \div 2) + 87.7) \times 216.1$	$((W \div 2) + 3 \frac{15}{32}) \times 8 \frac{17}{32}$

Drawer fronts (Height x Width)

Model	mm	inches
3176	149.2 x 216.1	5 7/8 x 8 17/32
3276	164.2 x 216.1	6 15/32 x 8 17/32
3376	189.2 x 216.1	7 15/32 x 8 17/32
3476	$((W \div 2) + 20.9) \times 216.1$	$((W \div 2) + 27/32) \times 8 \frac{17}{32}$

W = width
Default exterior profile: B

STANDARD SPECIFICATIONS

- White melamine back
- The default woodgrain direction is vertical

- Standard models drawer fronts are manufactured with reduced rails (unless regular rails are specified)
- Maximum door height: 2438 mm (96"), maximum door width: 1193 mm (47")

SERIES 83 Cat. 6 / 93 Cat. 5



Model **2183**
Color: K257S

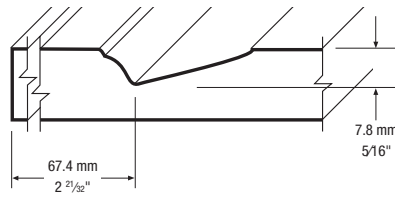

- 83 | Square interior corners
- 93 | Rounded interior corners



Model **3183**
Reduced rails



183

193



283

293



383

393



483

493

Minimum dimensions

Doors (Height x Width)

Model	mm	inches
2183/2193	201.5 x 201.5	7 15/16 x 7 15/16
2283/2293	216.5 x 201.5	8 17/32 x 7 15/16
2383/2393	241.5 x 230.8	9 17/32 x 9 3/32
2483/2493	$((W \div 2) + 112.5) \times 201.5$	$((W \div 2) + 4 7/16) \times 7 15/16$

Drawer fronts (Height x Width)

Model	mm	inches
3183/3193	138.3 x 201.5	5 15/32 x 7 15/16
3283/3293	153.3 x 201.5	6 1/16 x 7 15/16
3383/3393	178.3 x 230.8	7 1/32 x 9 3/32
3483/3493	$((W \div 2) + 49.3) \times 201.5$	$((W \div 2) + 1 31/32) \times 7 15/16$

W = width

Default exterior profile: C

Model **2193**
Color: K257S



93

Category 5

SERIES 85 Cat. 6 / 95 Cat. 5



Model **2185**
Color: K464WT

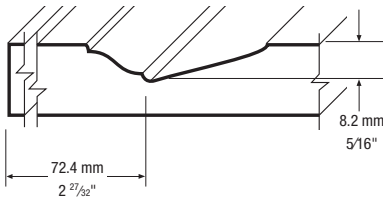

- 85 | Square interior corners
- 95 | Rounded interior corners



Model **3185**
Reduced rails



185

195



285

295



385

395



485

495

Minimum dimensions

Doors (Height x Width)

Model	mm	inches
2185/2195	212.4 x 212.4	8 3/8 x 8 3/8
2285/2295	227.4 x 212.4	8 31/32 x 8 3/8
2385/2395	252.4 x 250.8	9 15/16 x 9 7/8
2485/2495	$((W \div 2) + 117.5) \times 212.4$	$((W \div 2) + 4 21/32) \times 8 3/8$

Drawer fronts (Height x Width)

Model	mm	inches
3185/3195	149.2 x 212.4	5 7/8 x 8 3/8
3285/3295	164.2 x 212.4	6 15/32 x 8 3/8
3385/3395	189.2 x 250.8	7 15/32 x 9 7/8
3485/3495	$((W \div 2) + 54.3) \times 212.4$	$((W \div 2) + 2 5/32) \times 8 3/8$

W = width

Default exterior profile: C

Model **2195**
Color: K464WT



95

Category 5

STANDARD MODELS

OPTIONS:

- See availability of same color melamine back, pages 34-35.
- For regular rails drawer fronts, order as a door.

SERIES 86 Cat. 6 / 96 Cat. 5



Model **2186**
Color: R82S

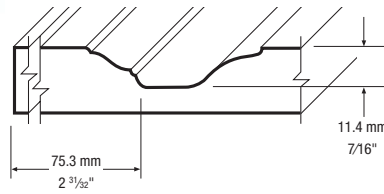

- 86 | Square interior corners
- 96 | Rounded interior corners



186
196



286
296



386
396



486
496



40.8 mm
1³⁹/₆₄"

Model **3186**
Reduced rails

Minimum dimensions

Doors (Height x Width)

Model	mm	inches
2186/2196	237.4 x 237.4	9 ³ / ₈ x 9 ³ / ₈
2286/2296	252.4 x 237.4	9 ¹⁵ / ₁₆ x 9 ³ / ₈
2386/2396	277.4 x 250.8	10 ¹⁵ / ₁₆ x 9 ⁷ / ₈
2486/2496	$((W \div 2) + 117.5) \times 237.4$	$((W \div 2) + 4 \frac{21}{32}) \times 9 \frac{3}{8}$

Drawer fronts (Height x Width)

Model	mm	inches
3186/3196	174.2 x 237.4	6 ⁷ / ₈ x 9 ³ / ₈
3286/3296	189.2 x 237.4	7 ¹⁵ / ₃₂ x 9 ³ / ₈
3386/3396	214.2 x 250.8	8 ⁷ / ₁₆ x 9 ⁷ / ₈
3486/3496	$((W \div 2) + 54.3) \times 237.4$	$((W \div 2) + 2 \frac{5}{32}) \times 9 \frac{3}{8}$

W = width
Default exterior profile: C

Model **2196**
Color: R82S



96

Category 5

SERIES 87 Cat. 6 / 97 Cat. 5



Model **2187**

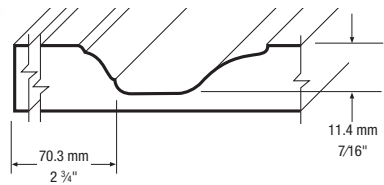

- 87 | Square interior corners
- 97 | Rounded interior corners



187
197



287
297



387
397



487
497



35.8 mm
1¹³/₃₂"

Model **3187**
Reduced rails

Minimum dimensions

Doors (Height x Width)

Model	mm	inches
2187/2197	227.4 x 227.4	8 ³¹ / ₃₂ x 8 ³¹ / ₃₂
2287/2297	242.4 x 227.4	9 ⁹ / ₁₆ x 8 ³¹ / ₃₂
2387/2397	267.4 x 230.8	10 ¹⁷ / ₃₂ x 9 ³ / ₃₂
2487/2497	$((W \div 2) + 112.5) \times 227.4$	$((W \div 2) + 4 \frac{7}{16}) \times 8 \frac{31}{32}$

Drawer fronts (Height x Width)

Model	mm	inches
3187/3197	164.2 x 227.4	6 ¹⁵ / ₃₂ x 8 ³¹ / ₃₂
3287/3297	179.2 x 227.4	7 ¹ / ₁₆ x 8 ³¹ / ₃₂
3387/3397	204.2 x 230.8	8 ¹ / ₁₆ x 9 ³ / ₃₂
3487/3497	$((W \div 2) + 49.3) \times 227.4$	$((W \div 2) + 1 \frac{31}{32}) \times 8 \frac{31}{32}$

W = width
Default exterior profile: C

Model **2197**



97

Category 5

STANDARD SPECIFICATIONS

- White melamine back
- The default woodgrain direction is vertical

- Standard models drawer fronts are manufactured with reduced rails (unless regular rails are specified)
- Maximum door height: 2438 mm (96"), maximum door width: 1193 mm (47")

SERIES 88 Cat. 6 / 98 Cat. 5



Model **2188**

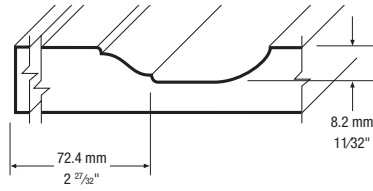

- 88 | Square interior corners
- 98 | Rounded interior corners



188



198



288



298



388



398



488



498



Model **3188**
Reduced rails

Minimum dimensions

Doors (Height x Width)

Model	mm	inches
2188/2198	214.9 x 214.9	8 15/32 x 8 15/32
2288/2298	229.9 x 214.9	9 1/16 x 8 15/32
2388/2398	254.9 x 250.8	10 1/16 x 9 7/8
2488/2498	$((W \div 2) + 117.5) \times 214.9$	$((W \div 2) + 4 21/32) \times 8 15/32$

Drawer fronts (Height x Width)

Model	mm	inches
3188/3198	151.7 x 214.9	6 x 8 15/32
3288/3298	166.7 x 214.9	6 9/16 x 8 15/32
3388/3398	191.7 x 250.8	7 9/16 x 9 7/8
3488/3498	$((W \div 2) + 54.3) \times 214.9$	$((W \div 2) + 2 5/32) \times 8 15/32$

W = width

Default exterior profile: C

Model **2198**



98
Category 5

SERIES 89 Cat. 6 / 99 Cat. 5



Model **2189**

Color: R825

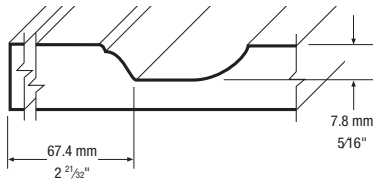

- 89 | Square interior corners
- 99 | Rounded interior corners



189



199



289



299



389



399



489



499



Model **3189**
Reduced rails

Minimum dimensions

Doors (Height x Width)

Model	mm	inches
2189/2199	204.4 x 204.4	8 1/16 x 8 1/16
2289/2299	219.4 x 204.4	8 21/32 x 8 1/16
2389/2399	244.4 x 230.8	9 5/8 x 9 3/16
2489/2499	$((W \div 2) + 112.5) \times 204.4$	$((W \div 2) + 4 7/16) \times 8 1/16$

Drawer fronts (Height x Width)

Model	mm	inches
3189/3199	141.2 x 204.4	5 9/16 x 8 1/16
3289/3299	156.2 x 204.4	6 5/32 x 8 1/16
3389/3399	181.2 x 230.8	7 5/32 x 9 3/16
3489/3499	$((W \div 2) + 49.3) \times 204.4$	$((W \div 2) + 1 31/32) \times 8 1/16$

W = width

Default exterior profile: C

Model **2199**

Color: R825



99
Category 5

STANDARD MODELS

OPTIONS:

- See availability of same color melamine back, pages 34-35.
- For regular rails drawer fronts, order as a door.

SERIES 912 Category 3



Model **2912**
Color: K85S

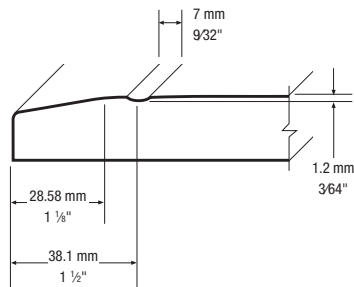

R = 3 mm (1/8")



Model **3912**
Regular rails

Minimum dimensions

Doors (Height x Width)

Model	mm	inches
2912	95.9 x 95.9	3 25/32 x 3 25/32

Drawer fronts (Height x Width)

Model	mm	inches
3912	95.9 x 95.9	3 25/32 x 3 25/32

Default exterior profile: F

Model 912 drawer fronts are manufactured with regular rails.

SERIES 01 Category 2



Model **2101**
Color: V66WT

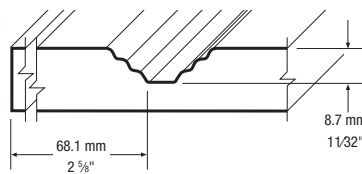

101



201



301



401



Model **3101**
Reduced rails

Minimum dimensions

Doors (Height x Width)

Model	mm	inches
2101	182.8 x 182.8	7 7/32 x 7 7/32
2201	201.3 x 182.8	7 15/16 x 7 7/32
2301	222.8 x 182.8	8 25/32 x 7 7/32
2401	((W÷2) + 71.6) x 182.8	((W÷2) + 2 27/32) x 7 7/32

Drawer fronts (Height x Width)

Model	mm	inches
3101	120.2 x 182.8	4 3/4 x 7 7/32
3201	138.7 x 182.8	5 15/32 x 7 7/32
3301	160.2 x 182.8	6 5/16 x 7 7/32
3401	((W÷2) + 9.0) x 182.8	((W÷2) + 3/8) x 7 7/32

W = width

Default exterior profile: C

STANDARD SPECIFICATIONS

- White melamine back
- The default woodgrain direction is vertical

- Standard models drawer fronts are manufactured with reduced rails (unless regular rails are specified)
- Maximum door height: 2438 mm (96"), maximum door width: 1193 mm (47")

SERIES 04 Category 2



Model **2104**
Color: V66WT

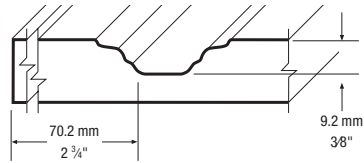

Model **3104**
Reduced rails

Minimum dimensions

Doors (Height x Width)

Model	mm	inches
2104	199.0 x 199.0	7 27/32 x 7 27/32
2204	214.0 x 199.0	8 7/16 x 7 27/32
2304	239.0 x 199.0	9 7/16 x 7 27/32
2404	$((W \div 2) + 75.1) \times 199.0$	$((W \div 2) + 2 31/32) \times 7 27/32$

Drawer fronts (Height x Width)

Model	mm	inches
3104	136.4 x 199.0	5 3/8 x 7 27/32
3204	151.4 x 199.0	5 31/32 x 7 27/32
3304	179.4 x 199.0	7 3/32 x 7 27/32
3404	$((W \div 2) + 12.5) \times 199.0$	$((W \div 2) + 1/2) \times 7 27/32$

W = width
Default exterior profile: C

SERIES 06 Category 3



Model **2106**
Color: K85S

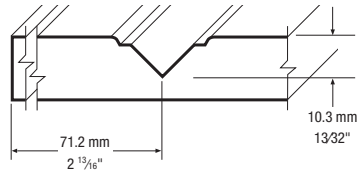

Model **3106**
Reduced rails

Minimum dimensions

Doors (Height x Width)

Model	mm	inches
2106	180.2 x 180.2	7 1/8 x 7 1/8
2206	195.2 x 180.2	7 11/16 x 7 1/8
2306	220.2 x 180.2	8 11/16 x 7 1/8
2406	$((W \div 2) + 81.5) \times 180.2$	$((W \div 2) + 3 7/32) \times 7 1/8$

Drawer fronts (Height x Width)

Model	mm	inches
3106	101.6 x 180.2	4 x 7 3/32
3206	116.6 x 180.2	4 19/32 x 7 3/32
3306	141.6 x 180.2	5 19/32 x 7 3/32
3406	$((W \div 2) + 2.9) \times 180.2$	$((W \div 2) + 1/8) \times 7 3/32$

W = width
Default exterior profile: B

STANDARD MODELS

OPTIONS:

- See availability of same color melamine back, pages 34-35.
- For regular rails drawer fronts, order as a door.

SERIES 07 Category 5



Model **2107**
Color: A661S

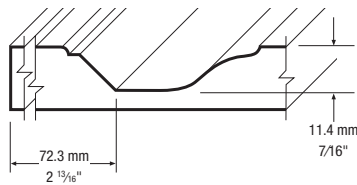

Minimum dimensions

Doors (Height x Width)

Model	mm	inches
2107	235.0 x 235.0	9 9/32 x 9 9/32
2207	250.0 x 235.0	9 27/32 x 9 9/32
2307	275.0 x 235.0	10 27/32 x 9 9/32
2407	$((W \div 2) + 86.8) \times 235.0$	$((W \div 2) + 3 7/16) \times 9 9/32$

Drawer fronts (Height x Width)

Model	mm	inches
3107	156.4 x 235.0	6 3/16 x 9 9/32
3207	171.4 x 235.0	6 3/4 x 9 9/32
3307	196.4 x 235.0	7 3/4 x 9 9/32
3407	$((W \div 2) + 8.2) \times 235.0$	$((W \div 2) + 1 1/32) \times 9 9/32$

W = width
Default exterior profile: B

SERIES 08 Category 3



Model **2108**
Color: A4WT

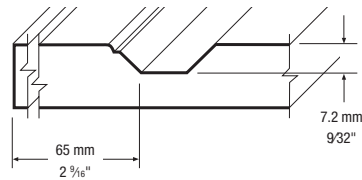

Minimum dimensions

Doors (Height x Width)

Model	mm	inches
2108	185.1 x 185.1	7 5/16 x 7 5/16
2208	200.1 x 185.1	7 29/32 x 7 5/16
2308	225.1 x 185.1	8 7/8 x 7 5/16
2408	$((W \div 2) + 71.8) \times 185.1$	$((W \div 2) + 2 27/32) \times 7 5/16$

Drawer fronts (Height x Width)

Model	mm	inches
3108	120.5 x 185.1	4 3/4 x 7 5/16
3208	135.5 x 185.1	5 11/32 x 7 5/16
3308	160.5 x 185.1	6 11/32 x 7 5/16
3408	$((W \div 2) + 7.8) \times 185.1$	$((W \div 2) + 5/16) \times 7 5/16$

W = width
Default exterior profile: B

STANDARD SPECIFICATIONS

- White melamine back
- The default woodgrain direction is vertical
- Standard models drawer fronts are manufactured with reduced rails (unless regular rails are specified)
- Maximum door height: 2438 mm (96"), maximum door width: 1193 mm (47")

SERIES 09 Category 3



Model **2109**
Color: A4WT

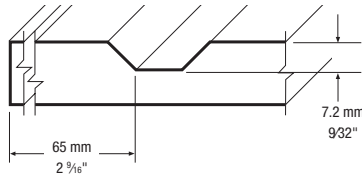

Model **3109**
Reduced rails

Minimum dimensions

Doors (Height x Width)

Model	mm	inches
2109	185.1 x 185.1	7 5/16 x 7 5/16
2209	200.1 x 185.1	7 29/32 x 7 5/16
2309	225.1 x 185.1	8 7/8 x 7 5/16
2409	$((W \div 2) + 71.8) \times 185.1$	$((W \div 2) + 2 27/32) \times 7 5/16$

Drawer fronts (Height x Width)

Model	mm	inches
3109	121.1 x 185.1	4 25/32 x 7 5/16
3209	136.1 x 185.1	5 3/8 x 7 5/16
3309	161.1 x 185.1	6 11/32 x 7 5/16
3409	$((W \div 2) + 7.8) \times 185.1$	$((W \div 2) + 5/16) \times 7 5/16$

W = width
Default exterior profile: B

SERIES 15 Category 2



Model **2115**
Color: A661S

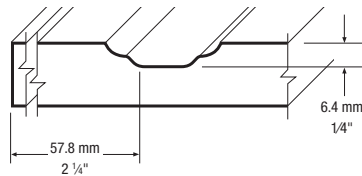

Model **3115**
Reduced rails

Minimum dimensions

Doors (Height x Width)

Model	mm	inches
2115	170.5 x 170.5	6 23/32 x 6 23/32
2215	185.8 x 170.5	7 11/32 x 6 23/32
2315	210.5 x 170.5	8 5/16 x 6 23/32
2415	$((W \div 2) + 63.1) \times 170.5$	$((W \div 2) + 2 1/2) \times 6 23/32$

Drawer fronts (Height x Width)

Model	mm	inches
3115	127.1 x 170.5	5 1/32 x 6 23/32
3215	142.1 x 170.5	5 5/8 x 6 23/32
3315	167.1 x 170.5	6 19/32 x 6 23/32
3415	$((W \div 2) + 19.7) \times 170.5$	$((W \div 2) + 25/32) \times 6 23/32$

W = width
Default exterior profile: U

STANDARD MODELS

OPTIONS:

- See availability of same color melamine back, pages 34-35.
- For regular rails drawer fronts, order as a door.

SERIES 31 Category 3

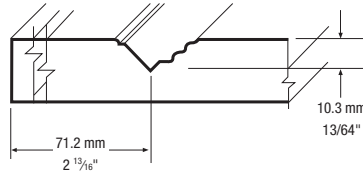

Model **2131**
Color: K464WT

Model **3131**
Reduced rails

Minimum dimensions

Doors (Height x Width)

Model	mm	inches
2131	199.4 x 199.4	7 27/32 x 7 27/32

Drawer fronts (Height x Width)

Model	mm	inches
3131	120.8 x 199.4	4 3/4 x 7 27/32

Default exterior profile: C

SERIES 32 Category 2

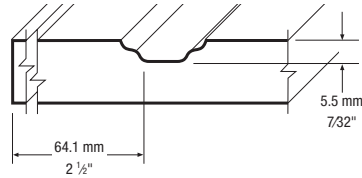

Model **2132**
Color: K257S

Model **3132**
Reduced rails

Minimum dimensions

Doors (Height x Width)

Model	mm	inches
2132	173.7 x 173.7	6 27/32 x 6 27/32
2232	188.7 x 173.7	7 7/16 x 6 27/32
2332	213.7 x 173.7	8 7/16 x 6 27/32
2432	$((W \div 2) + 68.8) \times 173.7$	$((W \div 2) + 2 23/32) \times 6 27/32$

Drawer fronts (Height x Width)

Model	mm	inches
3132	110.1 x 173.7	4 11/32 x 6 27/32
3232	125.1 x 173.7	4 15/16 x 6 27/32
3332	150.1 x 173.7	5 15/16 x 6 27/32
3432	$((W \div 2) + 5.2) \times 173.7$	$((W \div 2) + 7/32) \times 6 27/32$

W = width

Default exterior profile: C

STANDARD SPECIFICATIONS

- White melamine back
- The default woodgrain direction is vertical

- Standard models drawer fronts are manufactured with reduced rails (unless regular rails are specified)
- Maximum door height: 2438 mm (96"), maximum door width: 1193 mm (47")

SERIES 33 Category 3



Model **2133**
Color: K257S

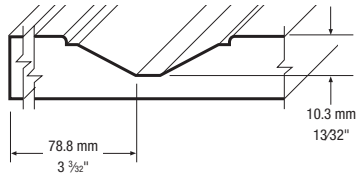

Model **3133**
Reduced rails

Minimum dimensions

Doors (Height x Width)

Model	mm	inches
2133	225.0 x 225.0	8 7/8 x 8 7/8
2233	240.0 x 225.0	9 15/32 x 8 7/8
2333	265.0 x 225.0	10 7/16 x 8 7/8
2433	$((W \div 2) + 82.5) \times 225.0$	$((W \div 2) + 3 1/4) \times 8 7/8$

Drawer fronts (Height x Width)

Model	mm	inches
3133	146.4 x 225.0	5 25/32 x 8 7/8
3233	161.4 x 225.0	6 3/8 x 8 7/8
3333	186.4 x 225.0	7 11/32 x 8 7/8
3433	$((W \div 2) + 3.9) \times 225.0$	$((W \div 2) + 5/32) \times 8 7/8$

W = width
Default exterior profile: A

SERIES 39 Category 3



Model **2139**
Color: K464WT

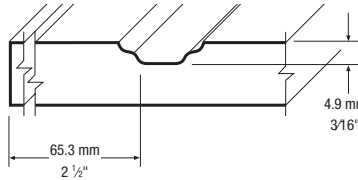

Model **3139**
Reduced rails

Minimum dimensions

Doors (Height x Width)

Model	mm	inches
2139	175.7 x 175.7	6 15/16 x 6 15/16
2239	190.7 x 175.7	7 17/32 x 6 15/16
2339	215.7 x 200.6	8 1/2 x 7 29/32
2439	$((W \div 2) + 70.0) \times 175.7$	$((W \div 2) + 2 25/32) \times 6 15/16$

Drawer fronts (Height x Width)

Model	mm	inches
3139	112.1 x 175.7	4 7/16 x 6 15/16
3239	127.1 x 175.7	5 1/32 x 6 15/16
3339	152.1 x 200.6	6 x 7 29/32
3439	$((W \div 2) + 6.4) \times 175.7$	$((W \div 2) + 9/32) \times 6 15/16$

W = width
Default exterior profile: C

STANDARD MODELS

OPTIONS:

- See availability of same color melamine back, pages 34-35.
- For regular rails drawer fronts, order as a door.

SERIES 46 Category 3



Model **2146**
Color: R82S

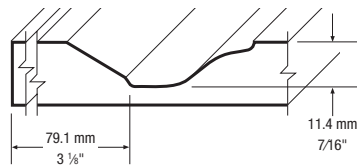

Minimum dimensions

Doors (Height x Width)

Model	mm	inches
2146	234.4 x 234.4	9 1/4 x 9 1/4
2246	254.4 x 234.4	10 1/32 x 9 1/4
2346	284.4 x 234.4	11 7/32 x 9 1/4
2446	$((W \div 2) + 86.5) \times 234.4$	$((W \div 2) + 3 13/32) \times 9 1/4$

Drawer fronts (Height x Width)

Model	mm	inches
3146	165.8 x 234.4	6 17/32 x 9 1/4
3246	185.8 x 234.4	7 11/32 x 9 1/4
3346	215.8 x 234.4	8 1/2 x 9 1/4
3446	$((W \div 2) + 17.9) \times 234.4$	$((W \div 2) + 23/32) \times 9 1/4$

W = width
Default exterior profile: C

SERIES 47 Category 2



Model **2147**

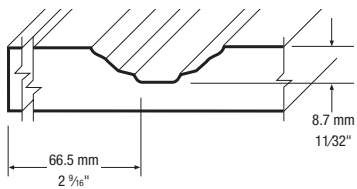

Minimum dimensions

Doors (Height x Width)

Model	mm	inches
2147	185.5 x 185.5	7 5/16 x 7 5/16
2247	200.5 x 185.5	7 29/32 x 7 5/16
2347	228.5 x 210.0	9 x 8 9/32
2447	$((W \div 2) + 69.8) \times 185.5$	$((W \div 2) + 2 3/4) \times 7 5/16$

Drawer fronts (Height x Width)

Model	mm	inches
3147	129.5 x 185.5	5 1/8 x 7 5/16
3247	144.5 x 185.5	5 23/32 x 7 5/16
3347	172.5 x 210.0	6 13/16 x 8 9/32
3447	$((W \div 2) + 13.8) \times 185.5$	$((W \div 2) + 9/16) \times 7 5/16$

W = width
Default exterior profile: C

STANDARD SPECIFICATIONS

- White melamine back
- The default woodgrain direction is vertical
- Standard models drawer fronts are manufactured with reduced rails (unless regular rails are specified)
- Maximum door height: 2438 mm (96"), maximum door width: 1193 mm (47")

SERIES 48 Category 3



Model **2148**

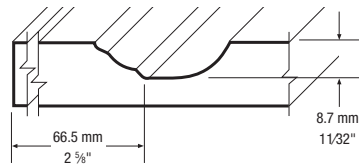

Model **3148**
Reduced rails

Minimum dimensions

Doors (Height x Width)

Model	mm	inches
2148	187.8 x 187.8	7 13/16 x 7 13/32
2248	202.8 x 187.8	8 x 7 13/32
2348	230.8 x 210.0	9 3/32 x 8 9/32
2448	$((W \div 2) + 73.1) \times 187.8$	$((W \div 2) + 2 29/32) \times 7 13/32$

Drawer fronts (Height x Width)

Model	mm	inches
3148	131.8 x 187.8	5 7/32 x 7 13/32
3248	146.8 x 187.8	5 25/32 x 7 13/32
3348	174.8 x 210.0	6 29/32 x 8 9/32
3448	$((W \div 2) + 17.1) \times 187.8$	$((W \div 2) + 1 1/16) \times 7 13/32$

W = width

Default exterior profile: C



SPECIAL MODELS

OPTION:

- See availability of same color melamine back, pages 34-35.



SERIES 908 Category 4

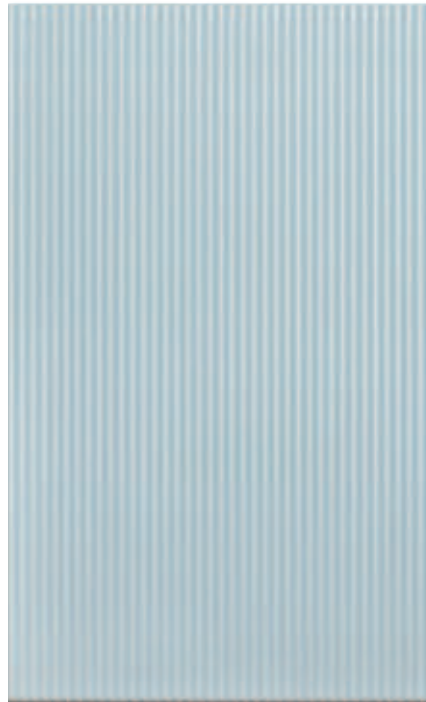

Model **2908**
Color: R80S

Minimum dimensions

Doors (Height x Width)

Model	mm	inches
2908/3908	76.2 x 76.2	3 x 3

Default exterior profile: I

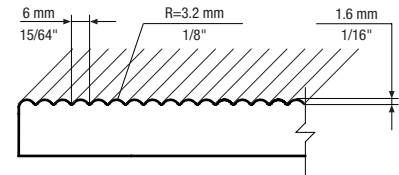

The first groove starts at the center of the door.

SERIES 916 Category 4

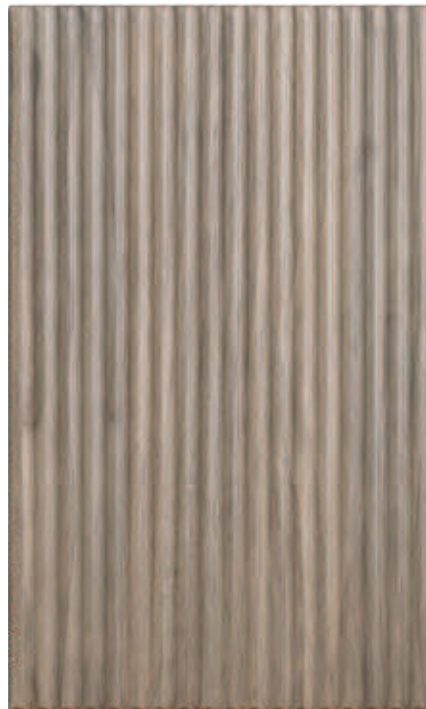

Model **2916**
Color: A60WT

Minimum dimensions

Doors (Height x Width)

Model	mm	inches
2916/3916	76.2 x 76.2	3 x 3

Default exterior profile: J

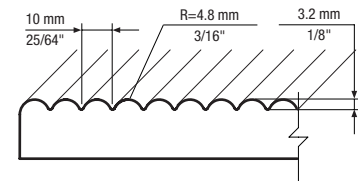

The first groove starts at the center of the door.

STANDARD SPECIFICATIONS

- White melamine back
- The default woodgrain direction is vertical

- Series 21 & 22 drawer fronts are manufactured with regular rails unless reduced rails are specified
- Maximum door height: 2438 mm (96"), maximum door width: 1193 mm (47")

SERIES 21 Category 4



Modèle **2121**
Couleur: R32S

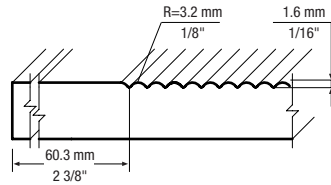

Minimum dimensions

Doors and drawer fronts (Height x Width)

Model	mm	inches
2121/3121	146.0 x 146.0	5 3/4 x 5 3/4

Reduced rails drawer fronts (Height x Width)

Model	mm	inches
3121red	76.0 x 146.0	3 x 5 3/4

Default exterior profile: I

Drawer fronts manufactured with standard rails (unless reduced rails are specified).

The first groove starts at the center of the door.

SERIES 22 Category 4



Modèle **2122**
Couleur: R32S

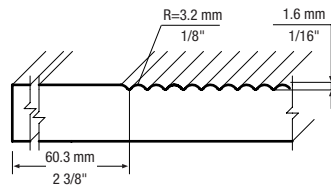

Minimum dimensions

Doors and drawer fronts (Height x Width)

Model	mm	inches
2122/3122	146.0 x 146.0	5 3/4 x 5 3/4

Reduced rails drawer fronts (Height x Width)

Model	mm	inches
3122red	76.0 x 146.0	3 x 5 3/4

Default exterior profile: I

Drawer fronts manufactured with standard rails (unless reduced rails are specified).

The first groove starts at the center of the door.

SPECIAL MODELS

OPTION:

- See availability of same color melamine back, pages 34-35.

SERIES 20 Category 4

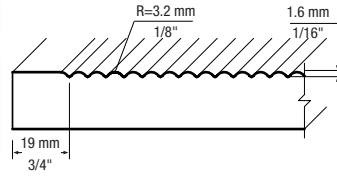

Model **2120**
Color: B780S

Minimum dimensions

Doors and drawer fronts (Height x Width)

Model	mm	inches
2120/3120	146.0 x 146.0	5 3/4 x 5 3/4

Default exterior profile: I

The first groove starts at the center of the door.
Frame and mullion doors are not available in this model.

SERIES 939 Category 3

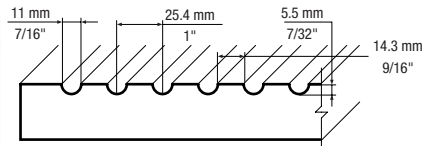

Model **2939**
Color: A4WT

Minimum dimensions

Doors (Height x Width)

Model	mm	inches
2939/3939	76.2 x 76.2	3 x 3

Default exterior profile: Q

Not available with exterior profile A.

Left and right rails will vary in width depending on the door dimensions.

An odd width is required for equal rails; add 14.3 mm (9/16").

An odd width is required for equal half-rails.

A 50.8mm (2") increment is required to ensure alignment of the grooves and the left and right rails.

STANDARD SPECIFICATIONS

- White melamine back
- The default woodgrain direction is vertical
- Drawer fronts are manufactured with reduced rails (unless regular rails are specified)
- Maximum door height: 2438 mm (96"), maximum door width: 1193 mm (47")

SERIES 996 Category 3



Model **2996**
Color: A661S

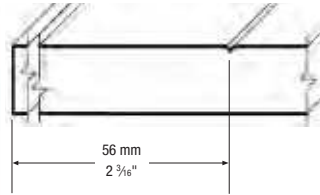

FRAME DOOR

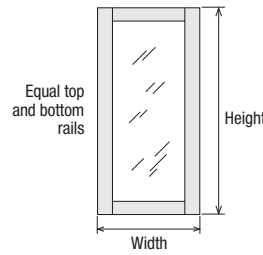

Minimum dimensions

Doors and drawer fronts (Height x Width)

Model	mm	inches
2996/3996	38.1 x 162.8	1 1/2 x 6 7/16

Note: Not available with exterior profiles D, F, H, and P
Default exterior profile: Y
The first groove is 48 mm (1-7/8") from the top of the door. Door rails height vary according to door dimensions.

ALIGNMENT OF ADJACENT DOORS AND DRAWERS

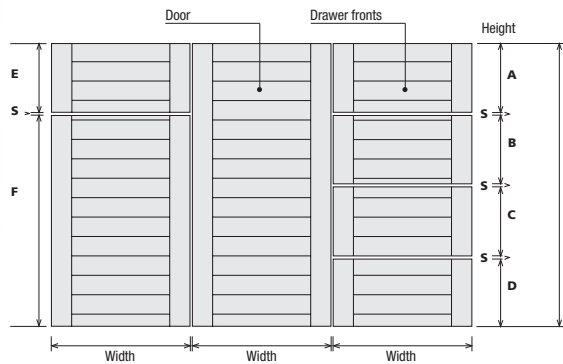

VERTICAL CROSS SECTION

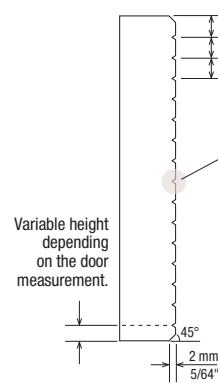

HORIZONTAL CROSS SECTION

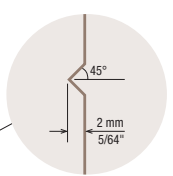

A, B, C, D, E, F and G: height of doors and drawers. / S: vertical space required between drawers.
To align the grooves with other doors and drawers front, please specify it when ordering and provide us a drawing.

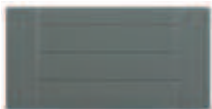

Model **3996**

GROOVES ON CENTER PANELS



Single Vertical Grooves

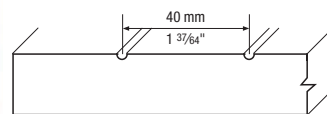

Model **2183**
Color: K464WT



Double Vertical Grooves

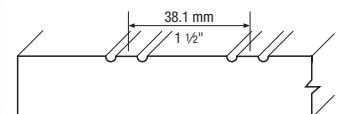

Model **2183**
Color: K464WT

If grooves are required on the door, this option must be specified.

Grooves on center panels are available on most door models. Please contact Customer Service for more information.

Groove depth: 1.6 mm - 1/16".

COLORS AND FINISHES

Color	Description	Color Group	Matching Melamine back	Foil with Peel & Stick	Official Melamine	Alternative Melamine	Official HPL	Alternative HPL	Thermo Edge banding	PVC Edge banding
A3WT	Weekend Getaway - Textured	B-C	•	•	Tafisa M2003 (Y)		Tafisa T2003-VA	Arborite W476-EV *		•
A4WT	Winter Fun! - Textured	B-C	•	•	Tafisa M2004 (Y)		Tafisa T2004-VA			•
A661S	Moon Light - Satin	B-C	•	•	Tafisa L761 (C)		Tafisa T761-CR	Formica 912-AN		•
B21R	White - Matte	A	White	•		Arauco W100 (Suede) EGGER W954-ST14 Panolam S411 (Crystal) Tafisa L080 (C) Tafisa L100 (C) Uniboard 113-DD Funder 971 (SD)		Pionite HP411-CR (SD) * Tafisa T080-CR Tafisa T100-CR	•	•
B44W	Chocolate Espresso - Matte	B-C	•	•	Tafisa L444 (C)		Tafisa T444-CR	Arborite W446-FP * Wilsonart 7942K-07 *	•	•
B54W	Designer White Woodgrain - Textured	A	White	•					•	
B175R	Snow White - Matte	B	White	•	Tafisa L175 (C)	Uniboard 555-SM EGGER W1100-ST9	Tafisa T175-CR	Wilsonart 15501-31		•
B775S	Gardenia - Satin	B	White	•	Tafisa PM775		Tafisa T775-PM			•
B776S	Cashmere - Satin	B	White	•	Tafisa PM776		Tafisa T776-PM			•
B777S	Winter Horizon - Satin	B	White	•	Tafisa PM777		Tafisa T777-PM			•
B778S	Steel Blue - Satin	B	White	•	Tafisa PM778		Tafisa T778-PM			•
B779S	Sage Leaf - Satin	B	White	•	Tafisa PM779		Tafisa T779-PM			•
B780S	Terrarossa - Satin	B	White	•	Tafisa PM780		Tafisa T780-PM			•
B920R	Vogue White - Matte	A	White	•				Pionite SW826-SD * (VE) * Uniboard 777-DD *	•	•
C35S	White - Satin	D	White	•				Pionite SW826-VE * (SD) *	•	•
C72R	Antique White - Matte	A-AA	•	•		Uniboard 810-DD (60) Panolam S463 (Satin)		Formica 463-58 * Formica 932-58 * Nevamar S7005-SD * Uniboard 810-DD * (60) * Wilsonart 1572-60 *	•	•
C72S	Antique White - Satin	D-E	•	•		Uniboard 810-DD (60) Panolam S463 (Satin)		Formica 463-58 * Nevamar S7005-SM * Uniboard 810-DD (60) * Wilsonart 1572-60 *		
C73R	Frosty White - Matte	A	White	•		Panolam S557 (Crystal) Panolam S411 (Crystal) Arauco W100 (Suede)			•	•
C92W	Hard Rock Maple - Matte	B-C	•	•	Uniboard 992-DD	Panolam W290 (Satin) Panolam W268 (Satin)	Uniboard 992-DD *	Nevamar WM5528-SD * Pionite WM791-SD *	•	•
D492W	White Chocolate - Textured	B-C	•	•	Tafisa L492 (R)		Tafisa T492-UR (CR)	Wilsonart 7976K-12 *		•
F434WT	Taction Oak Gibraltar - Textured	B-C	•	•	Arauco WF434	Panolam W150	Formica WF434-NG *	Pionite WY160-WE *		•
H109L	Grey High Gloss - High gloss	F	White	•				Wilsonart D381-01 *		•
K02W	Sesame - Satin	B-C	•	•	Uniboard K02-AU		Uniboard K02-AU	Wilsonart 8212-38 *		•
K16S	White - Super Matte	B	White	•		Arauco W100 (Satin) Funder 941 (EM)		Arborite S550-CA * Wilsonart 15501-31		•
K75S	Violet Grey - Satin	B	White	•		Funder 760 (EM)				•
K85S	Mysterious Blue - Satin	B-C	•	•	Arauco SF247	Funder 751 (EM)	Panolam FB247 *	Nevamar S3022-SM *		•
K168S	Canadian Grey - Satin	B-C	•	•	Uniboard K168-SM (DD)		Uniboard 168-SM *	Arborite S406-CA * Wilsonart D92-60 *		•
K233S	Gauntlet Grey - Satin	B-C	•	•	Arauco SF233		Panolam FB233 *	Wilsonart D504-38 * (60) *		•
K241S	Sienna - Satin	B-C	•	•	Arauco SF230		Panolam FB430 *	Arborite S508-VL *		•
K257S	Verde - Satin	B-C	•	•	Arauco SF257		Panolam FB257 *			•
K464WT	Urban Nomad - Textured	B-C	•	•	Arauco WF464			Alternative HPL not available. Heatshield filler: Wilsonart 8212K-28 *		•
K503S	Celadon Green - Satin	B-C	•	•	Arauco SF251	Funder 758 (EM)	Panolam FB251 *			•
K636S	Fjord - Satin	B-C	White	•						•
K961R	Stainless Steel - Matte	D-E	•	•	Uniboard 961-DD	Panolam A60 (Satin)	Uniboard 961-DD *	Pionite PEA60-SD *	•	•
P488W	Dolce Vita - Textured	B-C	•	•	Tafisa L488 (S)		Tafisa T488-SN (CR)			•
P489W	Copa Cabana - Textured	B-C	•	•	Tafisa L489 (S)		Tafisa T489-SN (CR)	Arborite W486-CW *		•
P501WT	Linear Ash - Textured	B-C	•	•	Arauco WF368		Formica W368-WR *	Arborite W498-CW *		•
P909R	Black - Matte	A-AA	Black	•		Uniboard 888-DD Uniboard 631-DD		Arborite S405-CA * Pionite SE101-SD * Wilsonart 1595-60 *	•	
R32S	Black - Super Matte	B-C	Black	•		Arauco BLK100 (Satin) Uniboard 888-DD Uniboard 631-DD		Wilsonart 1595-21 *		•

COLORS AND FINISHES

Color	Description	Color Group	Matching Melamine back	Foil with Peel & Stick	Official Melamine	Alternative Melamine	Official HPL	Alternative HPL	Thermo Edge banding	PVC Edge banding
R42L	Black - High Gloss	F-FF	Black - Matte	•		Uniboard 631-DD Uniboard 888-DD		Arborite S405-GL * Formica 909-90 * Wilsonart 1595-01 *		•
R49L	White - High Gloss	F	White - Matte	•				Wilsonart D427-01 *	•	•
R80S	Celestine - Satin	B-C	•	•	Uniboard K80-SM		Uniboard K80-SM *			•
R81S	Adobe - Super Matte	B	White	•	Uniboard K81-SM		Uniboard K81-SM *			•
R82S	White Smoke - Super Matte	B-C	•	•	Uniboard K82-SM (OM)		Uniboard K82-SM * (OM)	Formica 923-58 *		•
R83S	Shipshaw - Super Matte	B-C	•	•	Uniboard K83-SM (OM)		Uniboard K83-SM * (OM)	Formica 1097-58 *		•
R89WT	Cosmos - Textured	B-C	•	•	Uniboard K89-OM		Uniboard K89-OM			•
R105S	White - Super Matte	B	White	•	Tafisa L105 (I)	Arauco W100 (Velvet)	Tafisa T105-CR	Wilsonart 15511-31		•
R205W	Tobacco Cherry - Matte	B-C	•	•	Uniboard 205-DD	Panolam W18N Panolam W689	Uniboard 205-DD *	Nevamar W8371-T * Pionite HP689-SD *	•	•
R207W	Choco Cherry - Matte	B-C	•	•	Uniboard 207-DD		Uniboard 207-DD *	Arborite W415-FP * Formica 7739-58 *	•	•
R232S	Ashen - Satin	B-C	•	•	Arauco SF232		Formica SF232-58 * Panolam FB432 *	Nevamar S2069-T *		•
R237S	Charcoal - Satin	B	White	•	Arauco SF237	Uniboard 123-SM	Formica SF237-58 * Panolam FB237 *	Nevamar S6054-T * Pionite HP563-SD * Uniboard 123-SM *		•
R580WT	Free Spirit - Textured	B-C	•	•	Tafisa L580 (K)		Tafisa T580-KA			•
R581WT	Sheer Beauty - Textured	B-C	•	•	Tafisa L581 (K)		Tafisa T581-KA			•
R582WT	Fashionista - Textured	B-C	•	•	Tafisa L582 (K)		Tafisa T582-KA			•
R584WT	The Chameleon - Textured	B-C	•	•	Tafisa L584 (K)		Tafisa T584-KA			•
R660S	Rain Cloud - Satin	B-C	•	•	Tafisa L760 (C)	Funder 128 (SD)	Tafisa T760-CR	Formica 961-58 * Pionite SG213-SM *		•
R663S	Morning Dew - Satin	B-C	•	•	Tafisa L763 (C)	Uniboard 802-SM (DD)	Tafisa T763-PM (CR) (IS)	Arborite S431-CA * Uniboard 802-SM * (DD) * Wilsonart 1500-38 *		•
V66WT	Whisper - Textured	B-C	•	•	Uniboard K66-NO		Uniboard K66-NO	Arborite W485-CW *		•
V67WT	Rumour - Textured	B-C	•	•	Uniboard K67-NO	Panolam W171	Uniboard K67-NO	Pionite WA110-SD *		•
V202S	Summer Drops - Satin	B-C	•	•	Tafisa L202 (I) (C)		Tafisa T202-PM (CR)	Pionite SG241-SM * (SD) * Uniboard 805-SM *		•
V285WT	Jazz Silk - Textured	D	Black	•		Arauco BLK100 (Cascade)		Wilsonart 1595-12 *		•
V393WT	Concrete Groovz - Textured	B-C	•	•	Arauco WF393		Formica WF393-WR * (NG) * (58) *	Wilsonart 8239-38 *		•
V590WT	Love at First Sight - Textured	B-C	•	•	Tafisa L590 (K)		Tafisa T590-KA	Alternative HPL not available. Heatshield filler: Arborite W492-CW * Arborite C481-CW *		•
V591WT	Acacia Honey - Textured	B-C	•	•	Tafisa L591 (K)		Tafisa T591-KA			•
V592WT	Kiss Curl - Textured	B-C	•	•	Tafisa L592 (K)		Tafisa T592-KA			•
V593WT	Mastermind - Textured	B-C	•	•	Tafisa L593 (K)		Tafisa T593-KA			•
V629R	Ivory - Matte	A-AA	•	•	Tafisa L204 (C)	Panolam S463 (Satin) Funder 607 (SD)	Tafisa T204-CR	Wilsonart D403-60 *	•	•
VT00S	Suede Stone - Satin	A-AA	White	•	Olon VelourTouch VT00					•
VT01S	Cashmere Dusk - Satin	A-AA	White	•	Olon VelourTouch VT01					•
VT02S	Cotton Mist - Satin	A-AA	White	•	Olon VelourTouch VT02					•
VT03S	Black - Satin	A-AA	Black - Matte	•	Olon VelourTouch VT03	Uniboard 888-SM Funder 107 (EM)				•
VT06S	Oxford Grey - Satin	A-AA	•	•	Olon VelourTouch VT06	Tafisa L202 (I)**		Tafisa T202-CR Wilsonart 15503-31		•
VT08S	Warm Alpaga - Satin	A-AA	•	•	Olon VelourTouch VT08	Uniboard 168-SM**		Nevamar S6023-T * Uniboard 168-SM *		•
VT10S	Fresh Linen - Satin	A-AA	•	•	Olon VelourTouch VT10	Uniboard K82-SM		Formica 918-58 * Formica 934-58 * Uniboard K82-SM		•
VT11S	Merino Blue - Satin	A-AA	•	•	Olon VelourTouch VT11	Arauco SF247**		Nevamar S3022-SM * Panolam FB247 *		•
VT13S	Plush Forest - Satin	A-AA	White	•	Olon VelourTouch VT13					•
VT24S	Jersey Fog - Satin	A-AA	White	•	Olon VelourTouch VT24	Tafisa L760 (C)		Nevamar S6012-T * Pionite SG213-SD *		•
VT26S	Bamboo Shoots - Satin	A-AA	White	•	Olon VelourTouch VT26					•





• Available

* Postformed HPL heatshield filler available.

** Matching Melamine back available in alternative Melamine only.

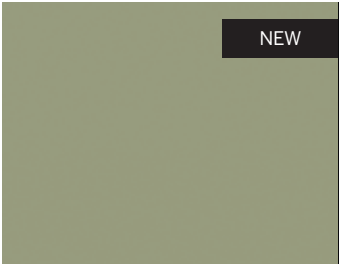
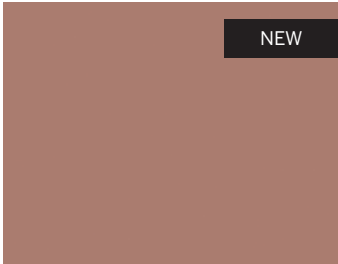
Premoule does not guarantee any of the compatible color options above. The ultimate responsibility rests solely with the end user with respect to acceptability of these options.

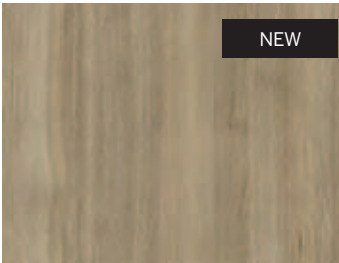
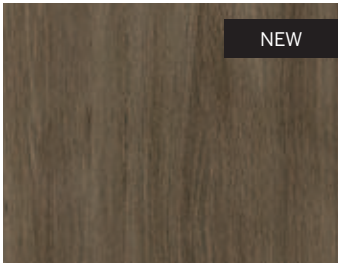
COLORS AND FINISHES

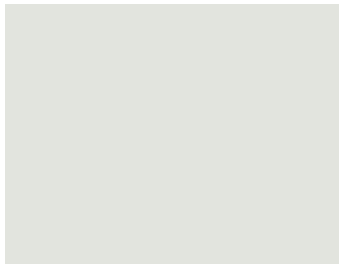
 <p>NEW</p>	 <p>NEW</p>	 <p>NEW</p>	 <p>NEW</p>
<p>B775S Gardenia - Satin</p>	<p>B776S Cashmere - Satin</p>	<p>B777S Winter Horizon - Satin</p>	<p>B778S Steel Blue - Satin</p>
 <p>NEW</p>	 <p>NEW</p>	 <p>NEW</p>	 <p>NEW</p>
<p>B779S Sage Leaf - Satin</p>	<p>B780S Terrarossa - Satin</p>	<p>R580WT Free Spirit - Textured</p>	<p>R581WT Sheer Beauty - Textured</p>
 <p>NEW</p>	 <p>NEW</p>		
<p>R584WT The Chameleon - Textured</p>	<p>R582WT Fashionista - Textured</p>	<p>B920R Vogue White - Matte</p>	<p>B175R Snow White - Matte</p>
			
<p>VT02S Cotton Mist - Satin</p>	<p>C35S White - Satin</p>	<p>R105S White - Super Matte</p>	<p>R49L White - High Gloss</p>
			
<p>K16S White - Super Matte</p>	<p>B21R White - Matte</p>	<p>C73R Frosty White - Matte</p>	<p>VT10S Fresh Linen - Satin</p>

COLORS AND FINISHES

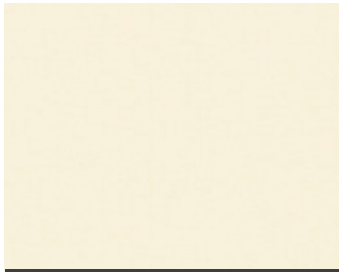

V629R
Ivory - Matte

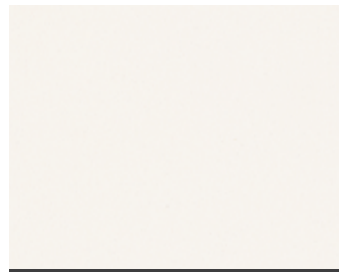

C72S
Antique White - Satin

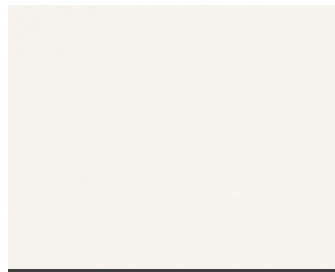

C72R
Antique White - Matte

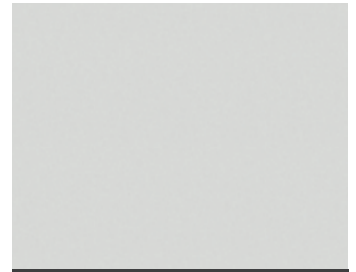

R82S
White Smoke - Super Matte



R663S
Morning Dew - Satin



VT00S
Suede Stone - Satin

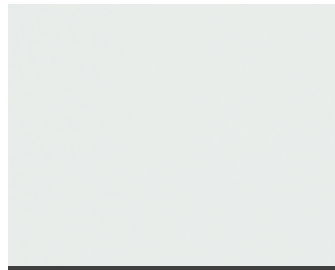

V202S
Summer Drops - Satin

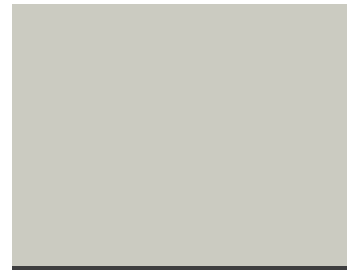

VT06S
Oxford Grey - Satin

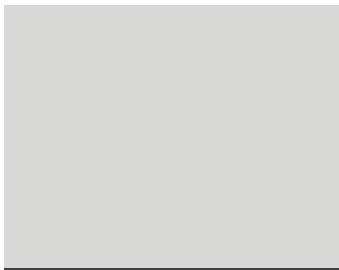

H109L
Grey High Gloss - High gloss



VT08S
Warm Alpaga - Satin

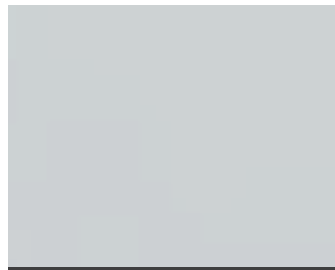

K168S
Canadian Grey - Satin

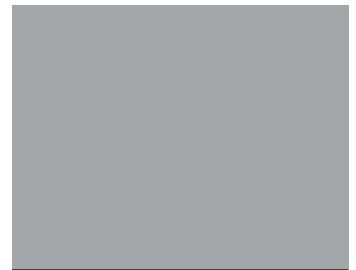

R660S
Rain Cloud - Satin

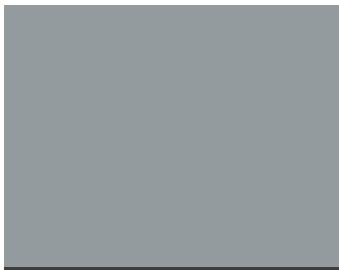

VT24S
Jersey Fog - Satin

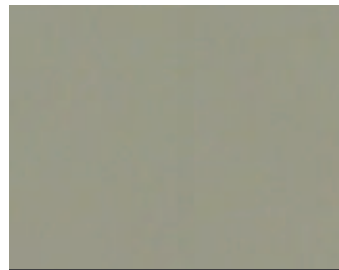

R232S
Ashen - Satin



R83S
Shipshaw - Super Matte

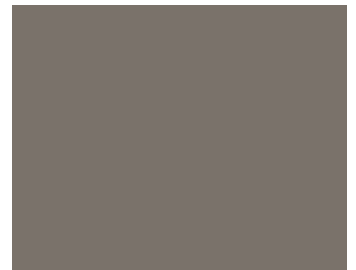

K233S
Gauntlet Grey - Satin

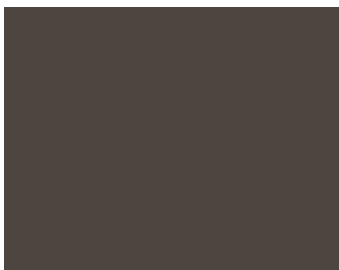

K241S
Sienna - Satin



A661S
Moon Light - Satin

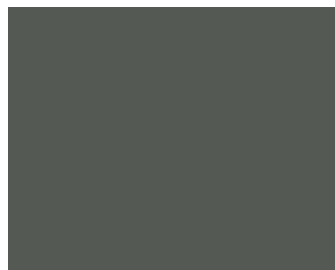

VT01S
Cashmere Dusk - Satin

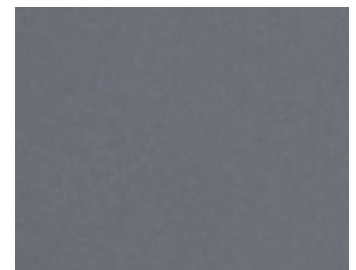

R237S
Charcoal - Satin

COLORS AND FINISHES



K75S
Violet Grey - Satin

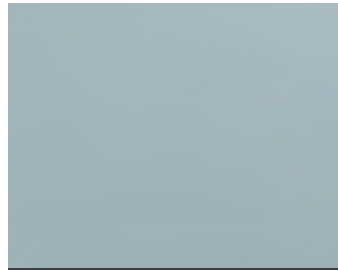

R80S
Celestine - Satin

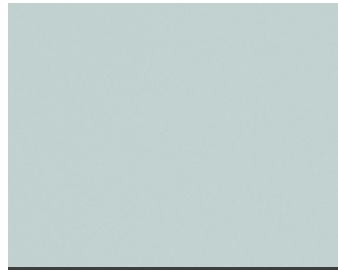

K636S
Fjord - Satin



VT26S
Bamboo Shoots - Satin



K503S
Celadon Green - Satin



K257S
Verde - Satin



VT13S
Plush Forest - Satin



K85S
Mysterious Blue - Satin



VT11S
Merino Blue - Satin

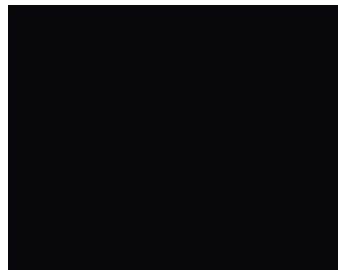

VT03S
Black - Satin



R32S
Black - Super Matte



P909R
Black - Matte

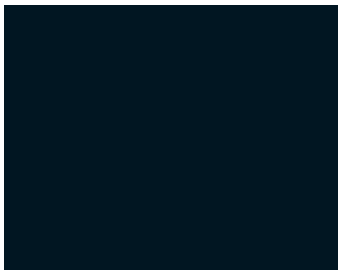

R42L
Black - High Gloss

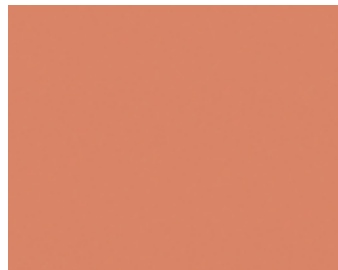

R81S
Adobe - Super Matte



K961R
Stainless Steel - Matte

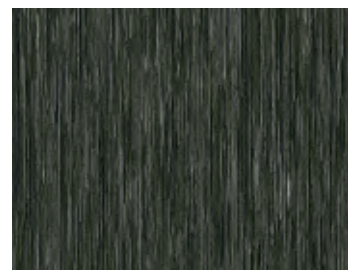

V285WT
Jazz Silk - Textured

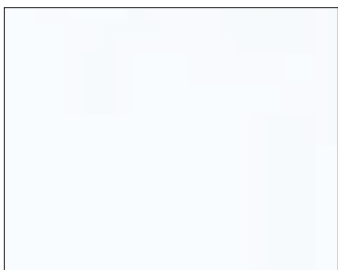

B54W
Designer White Woodgrain - Textured



D492W
White Chocolate - Textured



A4WT
Winter Fun! - Textured



A3WT
Weekend Getaway - Textured

COLORS AND FINISHES



V66WT
Whisper - Textured



K464WT
Nomade - Textured

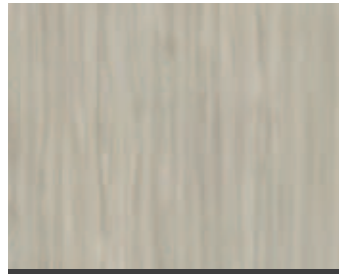

V593WT
Mastermind - Textured



V393WT
Concrete Groovz - Textured



K02W
Sesame - Satin

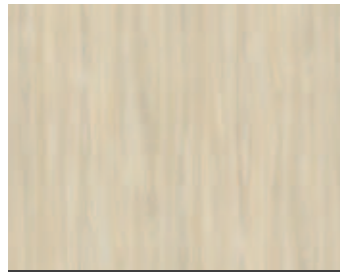

V590WT
Love at First Sight - Textured



R89WT
Cosmos - Textured



V591WT
Acacia Honey - Textured



C92W
Hard Rock Maple - Matte



V67WT
Rumour - Textured

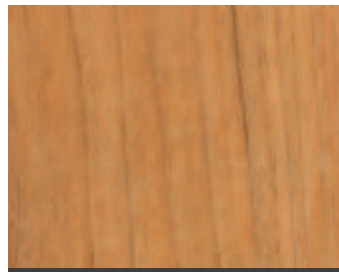

R205W
Tobacco Cherry - Matte



P488W
Dolce Vita - Textured

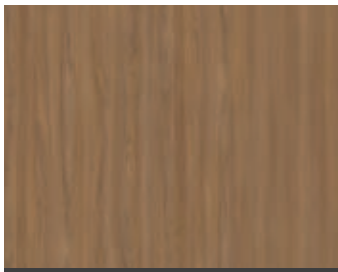

V592WT
Kiss Curl - Textured

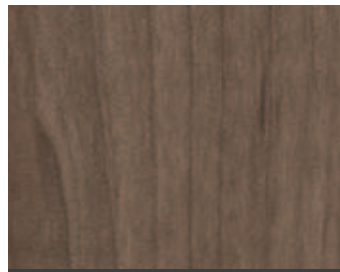

P489W
Copa Cabana - Textured

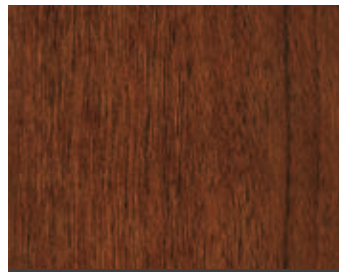

R207W
Choco Cherry - Matte

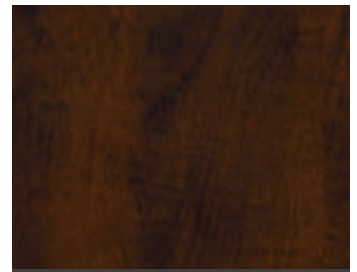

B44W
Chocolate Espresso - Matte



F434WT
Taction Oak Gibraltar - Textured

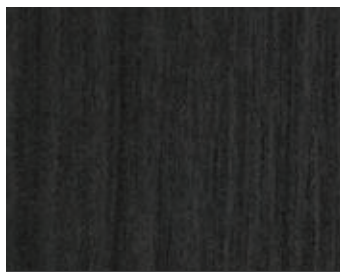

P501WT
Linear Ash - Textured



SIGNATURE TOUCH

FRAME AND
MULLION DOORS
PANELS
MOULDINGS
ACCESSORIES
TECHNICAL
SPECIFICATIONS

FRAME AND MULLION DOORS



Model **4101**
Color: V67WT

Standards

SERIES 4100

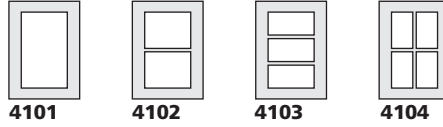

4101 **4102** **4103** **4104**

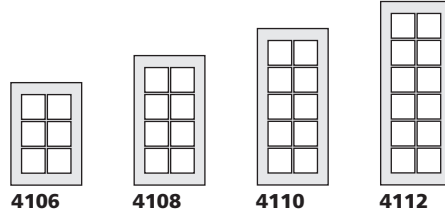

4106 **4108** **4110** **4112**

SERIES 4200

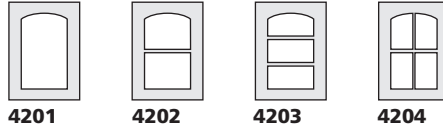

4201 **4202** **4203** **4204**

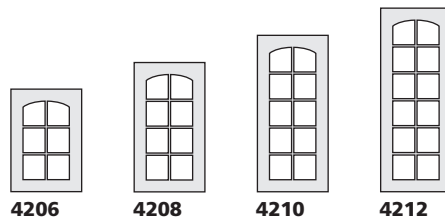

4206 **4208** **4210** **4212**

SERIES 4300



4301 **4302** **4303** **4304**

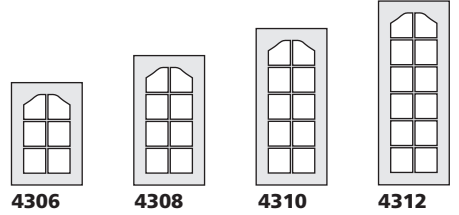

4306 **4308** **4310** **4312**

SERIES 4400



4401 **4402** **4403** **4404**

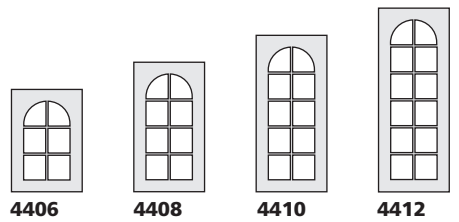

4406 **4408** **4410** **4412**



Model **4106**
Color: V67WT

Specials

SERIES 6300-6400

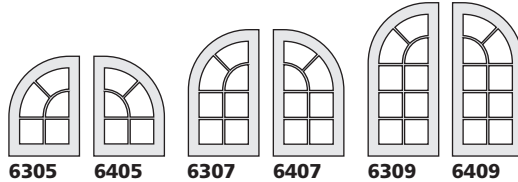

6305 **6405** **6307** **6407** **6309** **6409**

SERIES 6700

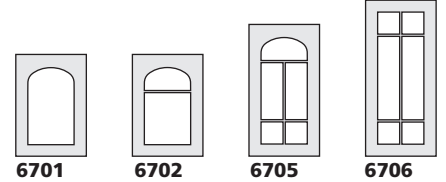

6701 **6702** **6705** **6706**

SERIES 6500-6600

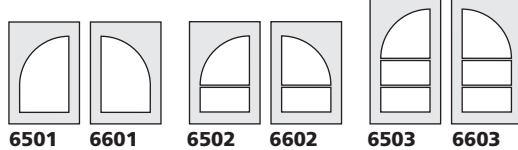

6501 **6601** **6502** **6602** **6503** **6603**

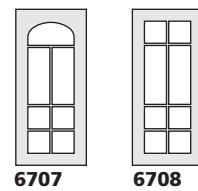

6707 **6708**



6505 **6605** **6507** **6607** **6509** **6609**

SERIES 6900

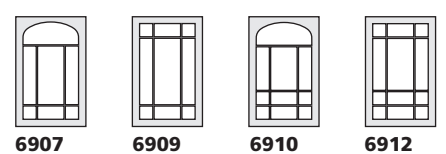

6907 **6909** **6910** **6912**

FRAME AND MULLION DOORS

OPTION:

MDF core will be visible on the back of the frame or mullion door. It can be painted on request.

SPECIFICATIONS

- 1) For special frame and mullion doors (except series 6900), the door heights must be identical to ensure alignment of the horizontal mullion.
- 2) By default, the interior profile of frame and mullion doors ordered with model 00 will be model 51.
- 3) By default, the interior profile of frame and mullion doors ordered with model 912 will be model 09.
- 4) Series 83 to 99 are limited to special frame and mullion doors 6706, 6708, 6909 and 6912. No restriction apply to series 93 to 99.
- 5) Mullion Doors ordered with models 942 and 996 are available only in the 4100 series.

Measurements to subtract to calculate the glass dimensions

Model	Height		Width	
	mm	inches	mm	inches
01-03-04-06-07-27-31-32-33-46-71-73	H - 115	H - 4 1/2	W - 115	W - 4 1/2
08-09-21-22-39-40-47-48-49-50-51-52-55-56-67-70-72-76-77-78-79-80-83-85-86-87-88-89-93-95-96-97-98-99-767-912-942-945	H - 102	H - 4	W - 102	W - 4
996	H - 88	H - 3 1/2	W - 102	W - 4
41-61-62-64-65-66-764	H - 127	H - 5	W - 127	W - 5
15-42	H - 91	H - 3 9/16	W - 91	W - 3 9/16

H = Height W = width

Glass Retainer Moulding

Model	Colors
5351	Clear
5350	White

Sold by the linear foot
(1 roll = 1000 linear feet)

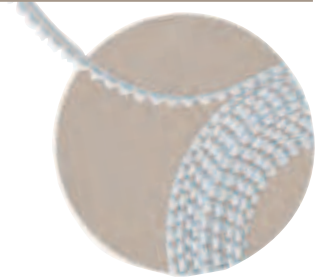

GLASS INSTALLATION

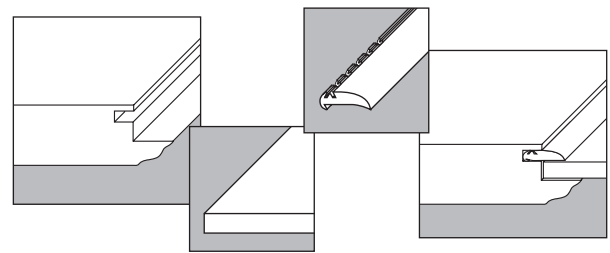

SPECIFICATIONS

Suggested glass thickness: 3 mm (1/8") to 5 mm (3/16").

For glass over 1219 mm (48"), the recommended glass thickness is 5 mm (3/16").

Minimum dimensions

Series 4100 - 4200 - 4300		Height x Width	
Model	Number of lites	mm	inches
4101, 4201, 4301	01	203.2 x 203.2	8 x 8
4102, 4202, 4302	02	279.4 x 203.2	11 x 8
4103, 4203, 4303	03	368.3 x 203.2	14 1/2 x 8
4104, 4204, 4304	04	279.4 x 279.4	11 x 11
4106, 4206, 4306	06	368.3 x 279.4	14 1/2 x 11
4108, 4208, 4308	08	457.2 x 279.4	18 x 11
4110, 4210, 4310	10	546.1 x 279.4	21 1/2 x 11
4112, 4212, 4312	12	635.0 x 279.4	25 x 11

Serie 4400		
Model	Number of lites	Height
4401	01	*
4402	02	H ≥ W
4403	03	H ≥ 1.4 x W
4404	04	H ≥ W
4406	06	H ≥ 1.4 x W
4408	08	H ≥ 1.8 x W
4410	10	H ≥ 2.2 x W
4412	12	H ≥ 2.6 x W

* Frames 4401 have the same minimum dimensions as their corresponding door model.

Series 6300 - 6400 - 6500 - 6600		
Model	Number of lites	Height
6305 - 6405	05	H ≥ 1.4 x W
6307 - 6407	07	H ≥ 1.6 x W
6309 - 6409	09	H ≥ 2 x W
6501 - 6601	01	H ≥ W
6502 - 6602	02	H ≥ 1.4 x W
6503 - 6603	03	H ≥ 1.6 x W
6505 - 6605	05	H ≥ 1.4 x W
6507 - 6607	07	H ≥ 1.6 x W
6509 - 6609	09	H ≥ 2.0 x W

The center of the radius is not calculated from the door rail. Please contact Customer Service for more information.

Serie 6700		
Model	Number of lites	Height
6701	1	≥ 0.6 x W
6702	2	≥ 0.9 x W
6705	5	≥ 1.5 x W
6706	6	≥ 1.5 x W
6707	7	≥ 1.9 x W
6708	8	≥ 1.9 x W

Series 6900			
Model	Number of lites	mm	inches
6907	07	500 x 444.5	19 11/16 x 17 1/2
6909	09	425 x 444.5	16 3/4 x 17 1/2
6910	10	600 x 444.5	23 5/8 x 17 1/2
6912	12	525 x 444.5	20 11/16 x 17 1/2

Note:

The numbers in the height calculation are multiplication factors, not millimeters or inches.

Multiple Panels



Model 5282
Color: V67WT



Model 5282
Double



Model 5283
Triple



Model 5284
Quadruple

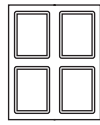

Model 5288
Quadruple

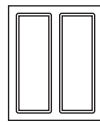

Model 5285
Double Split

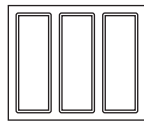

Model 5286
Triple Split

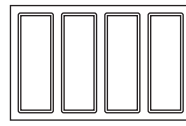

Model 5287
Quadruple Split

Appliance Panels

Appliance panels are available in the same models as the doors and multiple panels. However, their exterior is modified, as shown, to simplify their insertion.

Exterior profile A in this example.
Available exterior profiles: A, B, C, F, I, J, L, Y

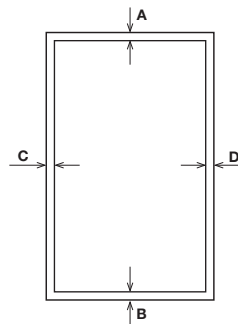
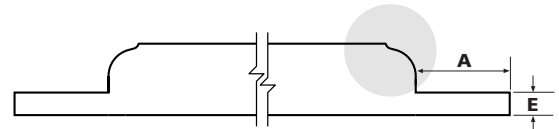

Model 5270
Simple

SPECIFICATIONS

Values from **A** to **E** must be specified. If not specified, default value for **E** will be 6.35 mm (1/4"). Minimum thickness for **E** is 4.76 mm (3/16").

AVAILABLE MODELS

- Simple (5270)
- Double (5272)
- Double Split (5275)
- Triple (5273)
- Triple Split (5276)
- Quadruple (5274, 5278)
- Quadruple Split (5277)

Frame for built-in appliances



Model 5566
Color: R205W

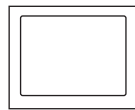

Model 5560

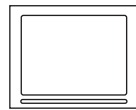

Model 5561

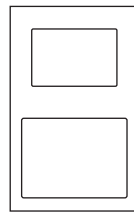

Model 5567

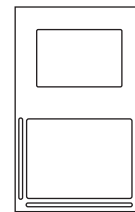

Model 5569

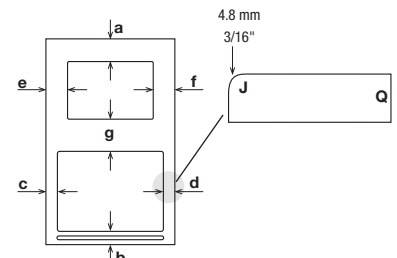

Model 5568

SPECIFICATIONS

- 1) The interior and exterior profiles of the frame are available in all exterior profiles. By default the interior profile if **J** and the exterior profile is **Q**.
- 2) Vents are centered on the height and width of the rail.
- 3) Minimum rails dimensions:
 - With vent, 50.8 mm (2");
 - Without vent, 38.1 mm (1 1/2")
- 4) The height of at least one opening must be specified for models 5567, 5568, 5569.

MOULDINGS AND ACCESSORIES

Thermoplastic Laminated Panels

Laminated particle board panels – Unilam – Phenolic paper

ONE SIDE: THERMO FRONT / WHITE UNILAM BACK

- 5011 : 15.86 mm x 1.2 m x 2.7 m (5/8" x 4' x 9')
- 5013 : 15.86 mm x 1.2 m x 2.4 m (5/8" x 4' x 8')
- 5015 : 19.05 mm x 1.2 m x 2.4 m (3/4" x 4' x 8')

BOTH SIDES: THERMO FRONT / THERMO BACK

- 5010 : 15.86 mm x 1.2 m x 2.7 m (5/8" x 4' x 9')
- 5012 : 15.86 mm x 1.2 m x 2.4 m (5/8" x 4' x 8')
- 5019 : 19.05 mm x 1.2 m x 2.4 m (3/4" x 4' x 8')

Laminated MDF Panels

ONE SIDE: THERMO FRONT / RAW MDF BACK

- 5014 : 6.3 mm x 1.2 m x 2.4 m (1/4" x 4' x 8')
- 5018 : 3.18 mm x 1.2 m x 2.4 m (1/8" x 4' x 8')
- 5027 : 19.05 mm x 1.2 m x 2.7 m (3/4" x 4' x 9')

Laminated MDF Panels

BOTH SIDES: THERMO FRONT / THERMO BACK

- 5017 : 19.05 mm x 1.2 m x 2.7 m (3/4" x 4' x 9')
- 5026 : 15.86 mm x 1.2 m x 2.4 m (5/8" x 4' x 8')

Laminated MDF Panels – Melamine

ONE SIDE : THERMO FRONT/ WHITE MELAMINE BACK

- 5016 : 19.05 mm x 1.2 m x 2.7 m (3/4" x 4' x 9')
- 5024 : 15.86 mm x 1.2 m x 2.7 m (5/8" x 4' x 9')
- 5025 : 15.86 mm x 1.2 m x 2.4 m (5/8" x 4' x 8')

Note: See pages 34-35 for colors availability.

Wine Racks

CIRCULAR OPENINGS



Model **5132**



Model **5133**

SPECIFICATIONS

- If models 5132 and 5133 are to be paired, it must be specified when placing your ordering.
- Minimum dimensions:
5132: 76.2 mm (3") height
5133: 69.8 mm (2 3/4") height



Model **5134**

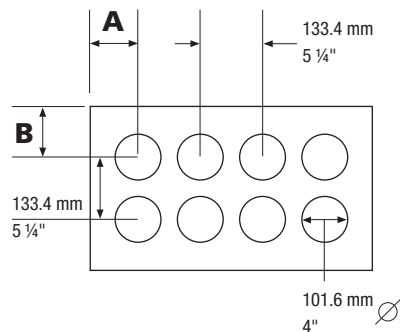

SPECIFICATIONS

- 1) Standard opening diameter: 101.6 mm (4")
- 2) Distance from the center of one opening to the center of the next.: 133.4 mm (5 1/4")
- 3) $A = \frac{\text{Width} - (\text{number of holes} - 1) \times 133.4 \text{ mm}}{\text{Width} - (\text{number of holes} - 1) \times 5 \frac{1}{4} \text{''}} \div 2$
 $B = \frac{\text{Height} - (\text{number of holes} - 1) \times 133.4 \text{ mm}}{\text{Height} - (\text{number of holes} - 1) \times 5 \frac{1}{4} \text{''}} \div 2$
- 4) **A** or **B** minimum dimension: 76.2 mm (3")

Model **5138**

DIAMOND OPENINGS



Model **5141**
Color: R205W



Model **5142**
Color: R205W



Model **5143**
Color: R205W

SPECIFICATIONS

Opening size: 101.6 x 101.6 mm (4" x 4")

Product	Number of openings	Minimum dimension		Maximum dimension	
		mm	in.	mm	in.
5134/5138	1	152.4	6	285.7	11 1/4
5132/5133	2	285.8	11 1/4	419.0	16 1/2
	3	419.1	16 1/2	501.6	19 3/4
	4	552.5	21 3/4	685.7	27
	5	685.8	27	819.1	32 1/4
	6	819.2	32 1/4	952.4	37 1/2
5141/5142	1	239.4	9 3/8	427.9	16 7/8
	2	428.0	16 7/8	616.5	24 1/4
	3	616.6	24 1/4	805.0	31 3/4
	4	805.1	31 3/4	993.6	39 1/8
	5	993.7	39 1/8	1182.2	46 1/2
	6	1182.3	46 1/2	1370.8	54
5143	1	194.5	7 3/8	383.0	15 1/8
	2	383.1	15 1/8	571.6	22 1/2
	3	571.7	22 1/2	760.1	29 7/8
	4	760.2	29 7/8	948.7	37 3/8
	5	948.8	37 3/8	1137.3	44 3/4
	6	1137.4	44 3/4	1325.9	52 1/4

MOULDINGS AND ACCESSORIES

Decorative Mouldings

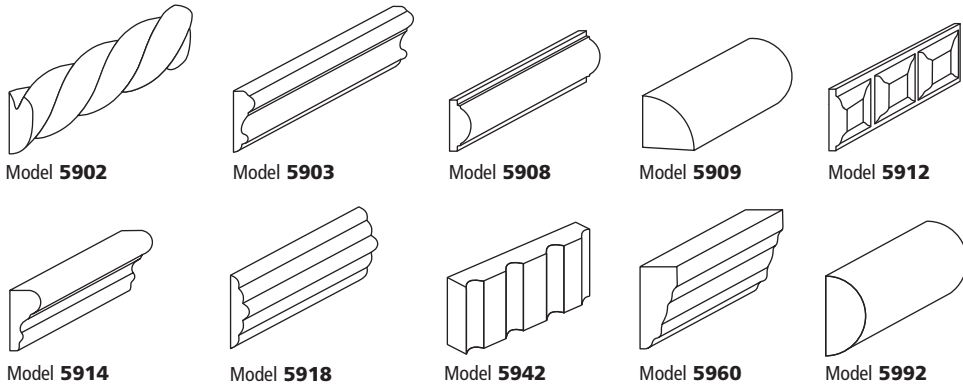

Model	Height x Thickness	
	mm	inches
5902	17.5 x 7	1 ¹ / ₁₆ x 9 ³ / ₃₂
5903	20.6 x 6.4	1 ³ / ₁₆ x 1 ¹ / ₄
5908	19 x 8	3 ³ / ₄ x 5 ⁵ / ₁₆
5909	19 x 19	3 ³ / ₄ x 3 ³ / ₄
5912	22.2 x 8	7 ⁷ / ₈ x 5 ⁵ / ₁₆
5914	25.4 x 12	1 x 1 ¹⁵ / ₃₂
5918	27 x 6.4	1 1 ¹ / ₁₆ x 1 ¹ / ₄
5942	25.4 x 19	1 x 3 ³ / ₄
5960	35 x 16	1 3 ³ / ₈ x 5 ⁵ / ₈
5992	38 x 19	1 1 ¹ / ₂ x 3 ³ / ₄

SPECIFICATIONS

- 1) Available in 2.4 m (8') lengths.
- 2) Definition of certain details varies according to the thickness of the thermoplastic foil.
- 3) Models 5902 and 5912: 2.4 m (94") lengths.
- 4) Decorative moldings are manufactured from finger-jointed pine.

Trim Moulding

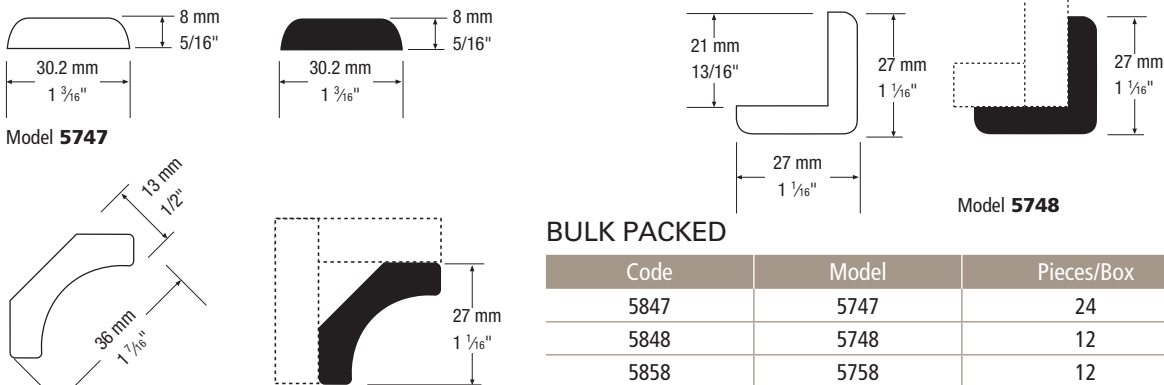

BULK PACKED

Code	Model	Pieces/Box
5847	5747	24
5848	5748	12
5858	5758	12

Trim moldings are manufactured from finger-jointed pine .
NOTE: Color restrictions apply for bulk packed moulding. Please consult price list.

Decorative moulding

Model 5767

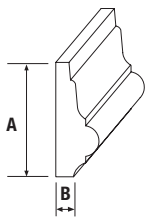

Height x Thickness

Model	mm	inches
5767	41.3 x 15.9	1 5 ⁵ / ₈ x 5 ³ / ₈

Decorative Base

Model 5590

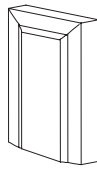

Height x Width

Model	mm	inches
5590	95.2 x 222.2	3 3 ³ / ₄ x 8 3 ³ / ₄

Decorative corner

Model 5540

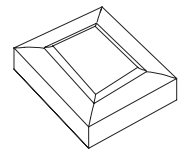

Height x Width

Model	mm	inches
5540	95.2 x 95.2	3 3 ³ / ₄ x 3 3 ³ / ₄

Baseboards

Model 5761

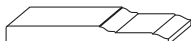

Model 5762



Height x Thickness		
Model	mm	inches
5761	139.7 x 15.2	5 1 ¹ / ₂ x 5 ⁵ / ₈
5762	108 x 15.2	4 1 ¹ / ₄ x 5 ⁵ / ₈

Frame mouldings



Model 5763



Model 5764

Height x Thickness		
Model	mm	inches
5763	68.3 x 15.2	2 1 ¹ / ₁₆ x 5 ⁵ / ₈
5764	79.4 x 15.2	3 1 ¹ / ₈ x 5 ⁵ / ₈

MOULDINGS AND ACCESSORIES

Crown mouldings

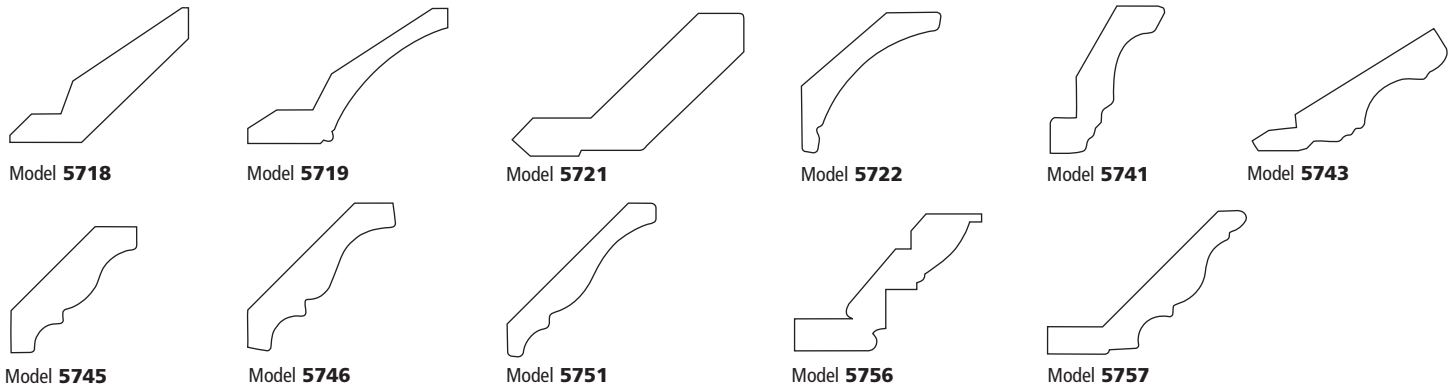

Model	Height x Thickness	
	mm	inches
5718	99.1 x 24.6	3 15/16 x 3 1/2
5719	99.1 x 25	3 15/16 x 1
5721	65.1 x 19.1	2 9/16 x 3/4
5722	102.25 x 31.71	4 x 3/4
5741	76.2 x 17.5	3 x 1 1/16
5743	90.5 x 17.5	3 9/16 x 1 1/16
5745	69.9 x 17	2 3/4 x 43/64
5746	80.2 x 17.5	3 5/32 x 1 1/16
5751	108 x 15	4 1/4 x 19/32
5756	88.9 x 19.1	3 1/2 x 3/4
5757	139.7 x 30	5 1/2 x 1 1/64

SPECIFICATIONS

- Available in 2.4 m (8') lengths.
- Available in all colors.

BULK PACKED

Code	Model	Pieces/Box
5841	5741	4
5843	5743	4
5845	5745	4
5846	5746	4
5856	5756	2
5857	5757	2

Note: some color restrictions apply. Please consult price list.

Installation

METHOD 1

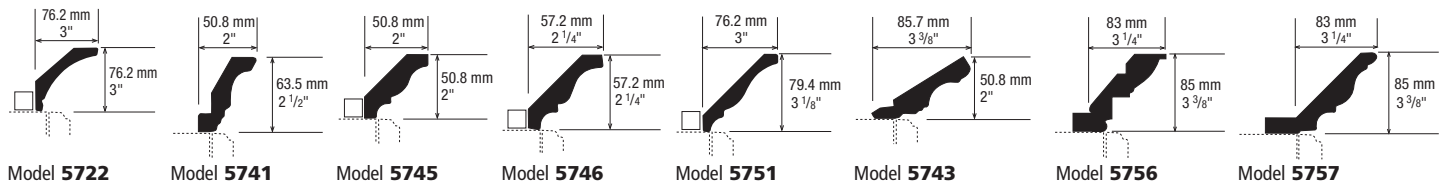

METHOD 2

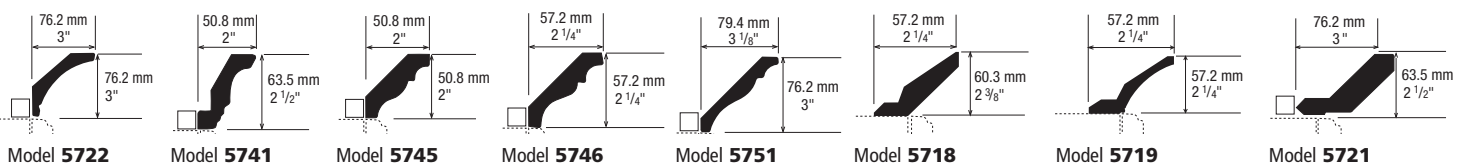

SPECIFICATIONS

Crown mouldings should be glued and clamped rather than nailed.

MOULDINGS AND ACCESSORIES

3" Standard Valances

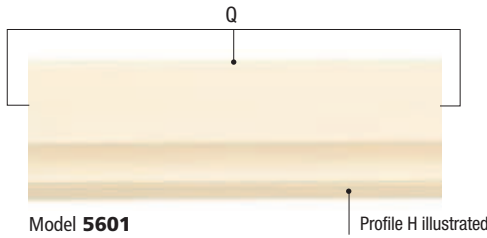

Standard dimensions (Height x Width)

Model	mm	inches	Profile
5601	76,2 x 2438	3 x 96	Bottom
5602	76,2 x 2438	3 x 96	Top & Bottom
5605	76,2 x 2438	3 x 96	Bottom

SPECIFICATIONS

- 1) Available with all exterior profiles (see page 2).
- 2) The default woodgrain direction is horizontal.

Custom Valances



Model **5610**
Color: C72R



Model **5620**
Color: C72R



Model **5631**
Color: C72R



Model **5640**
Color: C72R



Model **5650**
Color: C72R

Standards Dimensions

Custom valance standard dimensions have been established as shown below.

Therefore, custom valances ordered outside of these standards will require special programming.

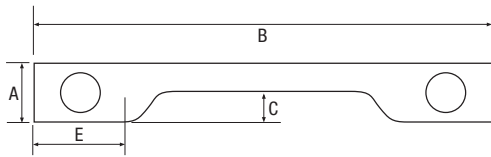

Models **5610-5611-5616**

- If $B < 609.6$ mm (24"), $E = 76.2$ mm (3")
- If $B \geq 609.6$ mm (24"), $E = 152.4$ mm (6")
- If $A < 203.2$ mm (8"), $C = 50.8$ mm (2")
- If $A \geq 203.2$ mm (8"), $C = 101.6$ mm (4")

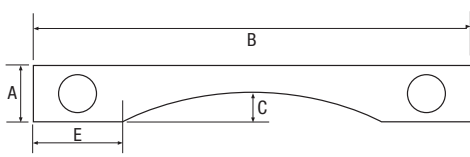

Models **5620-5621-5626, 5630-5631-5636**

- E is variable
- If $B < 508$ mm (20"), E minimum size is 76.2 mm (3") and E maximum size is 101.6 mm (4")
- If $B \geq 508$ mm (20"), E minimum size is 76.2 mm (3") and E maximum size is 165.1 mm (6 1/2")
- If $A < 203.2$ mm (8"), $C = 50.8$ mm (2")
- If $A \geq 203.2$ mm (8"), $C = 101.6$ mm (4")

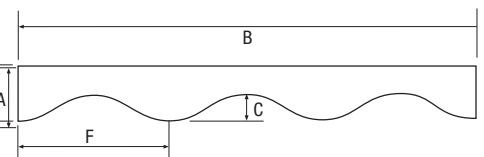

Models **5640**

- If $B < 762$ mm (30"), $F = 127$ mm (5") and $C = 25.4$ mm (1")
- If $B \geq 762$ mm (30"), $F = 254$ mm (10") and $C = 50.8$ mm (2")

Minimum dimensions

Model	A		B	
	mm	in.	mm	in.
5610 plain	101,6	4	330,2	13
5611 with 2 routed circles	101,6	4	330,2	13
5616 with 2 applied rosette	101,6	4	330,2	13
5620 plain	101,6	4	304,8	12

Model	A		B	
	mm	in.	mm	in.
5621 with 2 routed circles	101,6	4	304,8	12
5626 with 2 applied rosette	101,6	4	304,8	12
5630 plain	101,6	4	304,8	12
5631 with 2 routed circles	101,6	4	304,8	12

Model	A		B	
	mm	in.	mm	in.
5636 with 2 applied rosette	101,6	4	304,8	12
5640 plain	101,6	4	254	10
5650 plain	101,6	4	152,4	6

SPECIFICATIONS

- 1) Only the bottom edge is profiled. Please specify the edge profile.
- 2) Rosettes are centred vertically in the A dimension and horizontally in the E dimension.
- 3) Woodgrain pattern is horizontal. (Exeptions may apply, please contact Customer Sevice for further information.)

Valances (Designer Series)



Model **5510**
Country Manor

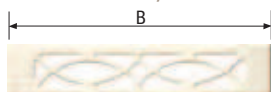

Model **5520**
Country Cottage

Model	Minimum dimensions				Standard dimensions			
	A		B		A		B	
	mm	in.	mm	in.	mm	in.	mm	in.
5510 Country Manor	152	6	235	9 1/4	152	6	762	30
5520 Country Cottage	152	6	304.8	12	152	6	762	30

SPECIFICATIONS

- 1) Back routing is identical to frame and mullion doors.
- 2) Model 5520 "Eye Shaped" pattern repeated every 355.6 mm (14").
- 3) All profiles available except D, F, H and P.
- 4) If width < 44 ", woodgrain direction is vertical.
- 5) If width > 44 ", woodgrain direction is horizontal.

MOULDINGS AND ACCESSORIES

Rosettes



Model **5530**
Color: C72R

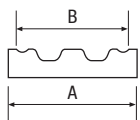

Model **5580**
Color: C72R

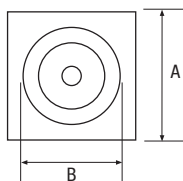
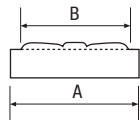

Standard dimensions

Model	A		B		C	
	Height x Width mm in.		Height x Width mm in.		Height x Width mm in.	
5530 circle rosette	76.2	3	68	2 1/16	19.1 - 25	3/4 - 1
5531 circle rosette (Shaker)	76.2	3	38.1	1 1/2	19.1 - 25	3/4 - 1
5580 applied rosette	76.2	3	63.5	2 1/2	19.1 - 25	3/4 - 1

SPECIFICATIONS

- 1) Not available with exterior profiles **H**, **P** and **V**.
- 2) A minimum of 88.9 mm (3 1/2") is required for all profiles except **Q** and **Y**.
- 3) Available with white melamine back only.

Decorative corner (Shaker)

Model **5531**

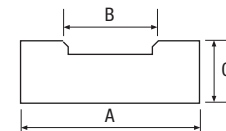

Minimum dimensions

Height x Thickness

Thickness	mm	inches
3/4"	76.2 x 76.2	3 x 3
1"	76.2 x 76.2	3 x 3

Shaker Filler

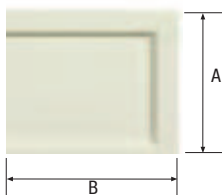

Model **5450**
Color: C72R

Standard dimensions

Model	A		B	
	mm	in.	mm	in.
5450	76.2	3	813	32

SPECIFICATIONS

- 1) Default exterior profile: **Q**.
- 2) Not available with exterior profiles: **H**, **P** and **V**.
- 3) Different lengths are available on request for **A** and **B**.

3" Radius Corners



Model **5300** Standard lengths
800 mm (31 1/2")

Model **5310** Standard lengths
2440 mm (96")

While supplies last



SPECIFICATIONS

- 1) Standard lengths: 800 mm (31 1/2"), 2440 mm (96"). Custom lengths also available as an option.

Fillers



Standard dimensions

Model	Description	A		B		C		D		E		F	
		mm	in.	mm	in.	mm	in.	mm	in.	mm	in.	mm	in.
5400	plain	76.2	3	-	-	813	32	-	-	-	-	-	-
5401	with 2 routed circles	76.2	3	114.3	4 1/2	813	32	-	-	-	-	68	2 1/16
5406	with 2 applied rosettes	76.2	3	114.3	4 1/2	813	32	-	-	-	-	63.5	2 1/2
5410	1 staggered groove	76.2	3	-	-	813	32	-	-	50.8	2	-	-
5411	1 staggered groove with 2 routed circles	76.2	3	114.3	4 1/2	813	32	177.8	7	50.8	2	68	2 1/16
5416	1 staggered groove with 2 applied rosettes	76.2	3	114.3	4 1/2	813	32	177.8	7	50.8	2	63.5	2 1/2
5420	2 grooves	76.2	3	-	-	813	32	177.8	7	-	-	-	-
5421	2 grooves with 2 routed circles	76.2	3	114.3	4 1/2	813	32	177.8	7	-	-	68	2 1/16
5426	2 grooves with 2 applied rosettes	76.2	3	114.3	4 1/2	813	32	177.8	7	-	-	63.5	2 1/2
5429	2 full length grooves	76.2	3	-	-	813	32	-	-	-	-	-	-
5430	3 grooves	76.2	3	-	-	813	32	177.8	7	-	-	-	-
5431	3 grooves with 2 routed circles	76.2	3	114.3	4 1/2	813	32	177.8	7	-	-	68	2 1/16
5436	3 grooves with 2 applied rosettes	76.2	3	114.3	4 1/2	813	32	177.8	7	-	-	63.5	2 1/2
5439	3 full length grooves	76.2	3	-	-	813	32	-	-	-	-	-	-

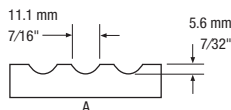
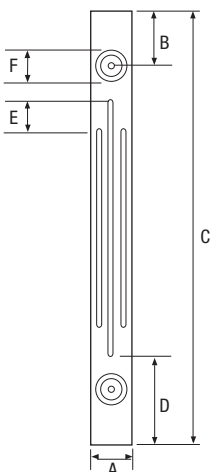

Note: If **C** is < 609,6 mm (24")
B = 38,1 mm (1 1/2")
D = 101,6 mm (4")
E = 25,4 mm (1")

SPECIFICATIONS

- 1) Default exterior profile: **Q**.
- 2) Not available with exterior profiles **H**, **P** and **V**.
- 3) The ratio is one groove per inch unless specified otherwise.
- 4) Different lengths are available on request for **A**, **B**, **C**, **D**, **E**.

MOULDINGS AND ACCESSORIES

Heatshield Fillers

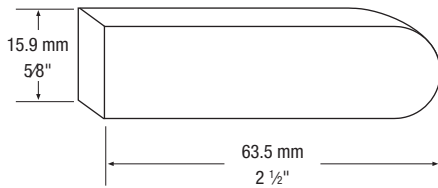
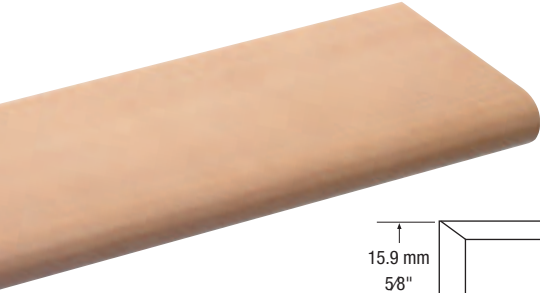

Heatshield fillers are high-heat-resistant fillers/spacers for kitchen cabinet installations near a heat source. **HPL Heatshield fillers** are postformed components with a 180° profile, subjected to pretesting at temperatures exceeding 120°C (250°F) without delamination

Produced in an HPL compatible color, Heatshield fillers are available in many colors. Please refer to pages 34-35 or contact Customer Service for updated compatible color options.

SPECIFICATIONS

Model	m	ft
5315	1.2	4
5316	2.4	8

A 25.4 mm (1") HPL strip is supplied with each heatshield filler. After cutting the heatshield filler to the correct length, use the HPL strip to edge the ends. Not available in color K16S and C35S.

Installation

CLEAR PLASTIC HEATSHIELD FILLERS



Model **5317**
5/8"
Length 2.4 m (8')

Model **5318**
3/4"
Length 2.4 m (8')

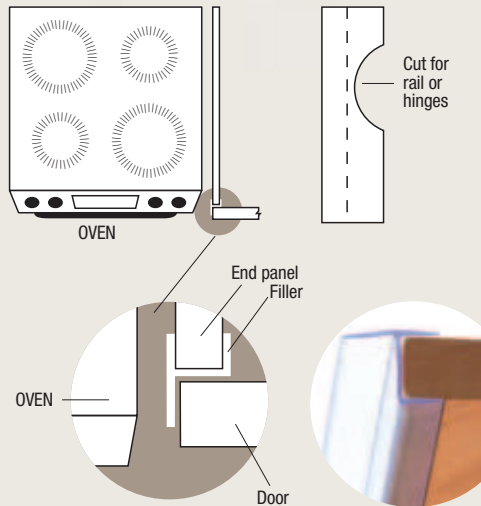

The clear plastic heatshield is a great option for cabinet installation close to a heat source. With the same resistance to heat as the HPL Heatshield fillers (250 °F / 120 °C), this clear plastic heatshield is compatible with all thermoplastic colors. It is easily installed along the edge of the end panel and requires no adhesive. If installing the heatshield around hinges or rails, a simple cut on the interior of the heatshield is sufficient.

WALL MOUNTED OVENS

The use of heatshield fillers is recommended, as mentioned for base ovens and cooktops. In addition, a 5/8"-3/4" filler should be fitted horizontally between the oven and the top door, aligned with the door surface.

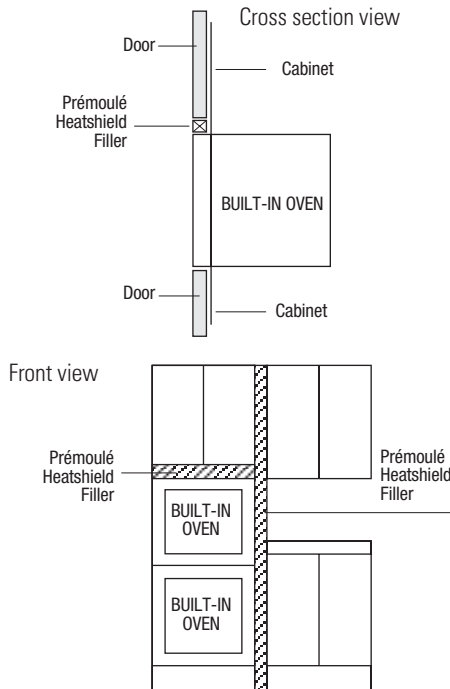

WALL MOUNTED MICROWAVE OVENS AND UNDERMOUNT COFFEE MAKERS

The heatshield filler mounted flush, or protruding slightly beyond the face surfaces of doors above, is recommended. This precludes possible surface damage and swelling of core material from excessive heat and/or steam.

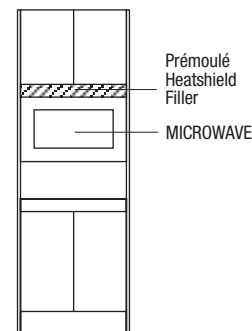

BASE OVENS AND COOK TOPS

The heatshield filler must be mounted so that its surface is aligned with the adjacent door surface. The same recommendation applies to cook tops with front exhaust vents. The filler acts as a shield against excessive radiant and convective heat associated with broiling (with the oven door open) and ovens with self-cleaning features.

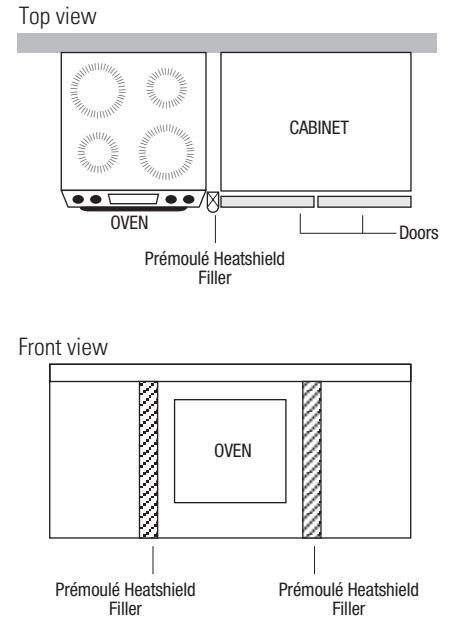

RESTRICTION

Counter top appliances: Care must be taken when using toasters, toaster ovens, portable grills and other heat/steam generating appliances to ensure that upper cabinet doors are not subjected to excessive temperatures

MOULDINGS AND ACCESSORIES

Corner Shelves

SHELF WITH RADIUS



Model **5120**

NOTE: Same color melamine back available.

SHELF WITH ELLIPSE



Model **5121**

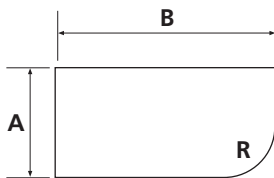

If **A** or **B** < 203.2 mm (8"), **R** = 88.9 mm (3 1/2")

If **A** and **B** ≥ 203.2 mm (8"), **R** = 190.5 mm (7 1/2")

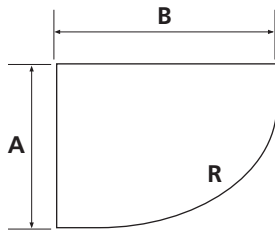

If **A** or **B** sizes are between:

101.6 mm (4") – 152.4 mm (6"), **R** = 101.6 mm (4")

152.4 mm (6") – 203.2 mm (8"), **R** = 152.4 mm (6")

203.2 mm (8") – 254 mm (10"), **R** = 203.2 mm (8")

254 mm (10") – 381 mm (15"), **R** = 254 mm (10")

NOTE: Minimum size for **A** and **B** is 89 mm (3 1/2")

Decorative Tambours

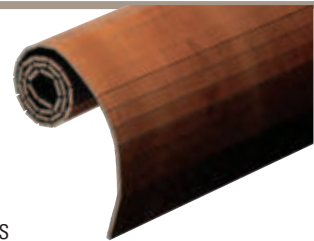

Available dimensions

Model Thickness 3.2 mm x 1/8 in.	Model Thickness 6.4 mm x 1/4 in.	m	pi.
5005	5055	0.6 x 0.6	2 x 2
5003	5052	0.6 x 1.2	2 x 4
5004	5054	1.2 x 1.2	4 x 4

SPECIFICATIONS

- Strip width: 12.7 mm (1/2")
First strip: 38.1 mm (1 1/2")
- The default woodgrain direction is vertical.
Horizontal woodgrain available as an option.

Thermoplastic Foil

Thermoplastic sheet

- 5000: 1.2 m (4') wide.
Length must be specified

Peel and stick

- 5040 : 1.2 m x 2.4 m (4' x 8')
- 5041 : 1.2 m x 3.0 m (4' x 10')
- 5042 : 1.2 m x 3.6m (4' x 12')

Thermoplastic on phenolic (Thin HPL phenolic back).

- 5060 : 1.2 m x 2.4 m (4' x 8')

Note: See pages 34-35 for the available colors.

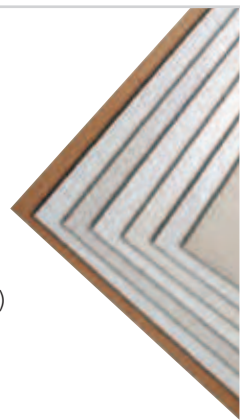

Edgebanding

Our thermoplastic edgebanding is formulated to be used with edgebanding machines operating at 77 °C (170 °F). Since standard edgebanding machines run at 88 °C (190 °F) to 99 °C (210 °F), we also offer PVC edgebanding which can be applied with the standard machines. Available finishes for each type of edgebanding are listed in the table on page 34-35.

Thermoplastic Edgebanding

- 25.4 mm (1") wide
- 100 m (328') roll (5008)
- 2.4 m (8') length (5009)

PVC Edgebanding

- 23.8 mm (1 5/16") wide
- 182.9 m (600') roll (5050)

SPECIFICATIONS

- Our warranty is applicable on thermoplastic products and does not apply to PVC edgebanding.
- If PVC edgebanding is applied manually, we recommend using a high quality water-based contact adhesive to avoid damaging adjacent thermoplastic surfaces.
- Thickness: 0.5 mm (0.018").



End Panels

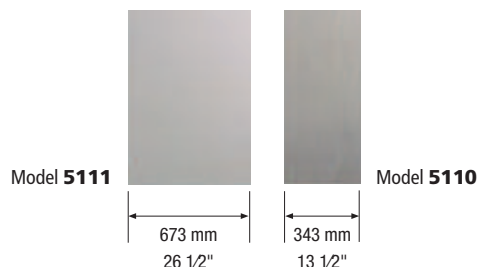

Available dimensions

Model 1 face	Model 2 faces	mm	in.
5110	5116	343 x 2440	13 1/2 x 96
5111	5117	673 x 2440	26 1/2 x 96

SPECIFICATIONS

- All exterior profiles available
- Custom dimensions also available.

TECHNICAL SPECIFICATIONS

Product Properties

Height and width tolerance

- ± 0.5 mm (0.020")

Warp tolerance per linear foot

- $\pm 0,8$ mm (1/32"). Refer to page 52 for recommended hinge holes.

Heat resistance

- 85 °C (185 °F). See page 49 for installation near heat sources.

Product Care and Maintenance

Thermoplastic doors can be easily cleaned with mild soap and water. However, as with any quality product, there are certain precautions you can take to preserve its value.

- Avoid the use of harsh chemicals, such as lacquer thinner, bleach or cleansers containing solvents or abrasives; especially avoid products containing toluene or acetone.
- Avoid bumping or hitting surface with a sharp object, since it could result in a permanent indentation or cut. In the event of abuse, minor surface scratches can sometimes be removed depending on the severity of the damage. The following is recommended:
 - 1) Rub the scratched area with a high grade polishing compound.
 - 2) Polish the area with a caruba based wax.
 - 3) Repair kits are available from paint companies specializing in touch up paints.
- Avoid exposure of doors and drawers to high heat. To ensure against damage to doors or drawers, please do the following:
 - 1) When broiling with oven door open, open doors and drawers of adjacent cabinets to minimize exposure to high heat.
 - 2) Since the door seals on some ranges and ovens allow high heat to escape during the self cleaning cycle, as a precaution, open or remove doors and drawers of adjacent cabinets during the self cleaning cycle. Please read the warranty and instructions for your appliances.
 - 3) Be aware of countertop appliances such as boilers, toasters and toaster ovens that create high heat conditions. They should not be directly under doors of overhead cabinets while in use.

Drawers fronts

We recommend ordering drawers fronts as doors rather than as reduced rails drawer fronts when they are over 228.6 mm (9") high.

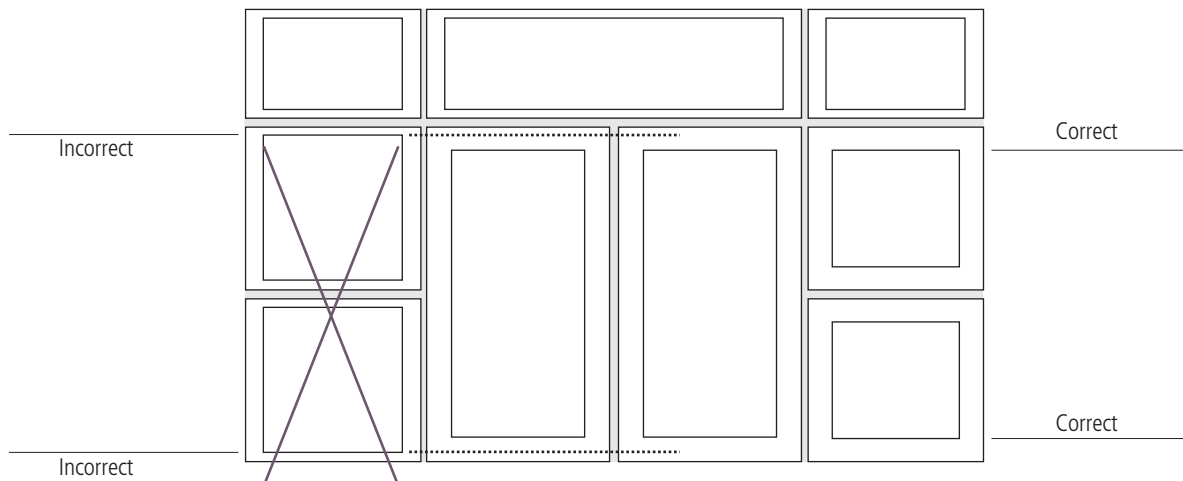

TECHNICAL SPECIFICATIONS

Fingerpull

The descriptive codes for fingerpull location have been simplified. (*) in the new code correspond to the exterior profiles selected. Please replace the asterisk (*) by the exterior profile letter.

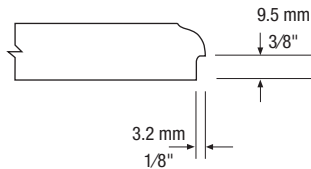

- 1) Can be added to all exterior profiles except **G, H, L, M** and **S**.
- 2) Fingerpulls 4***, *4**, **4* and ***4 will be full length – starting 25.4 mm (1") from one side and ending 25.4 mm (1") from the other side.
- 3) All other fingerpulls will be 101.6 mm (4") wide. Fingerpulls on the corners will be 25.4 mm (1") from the end.

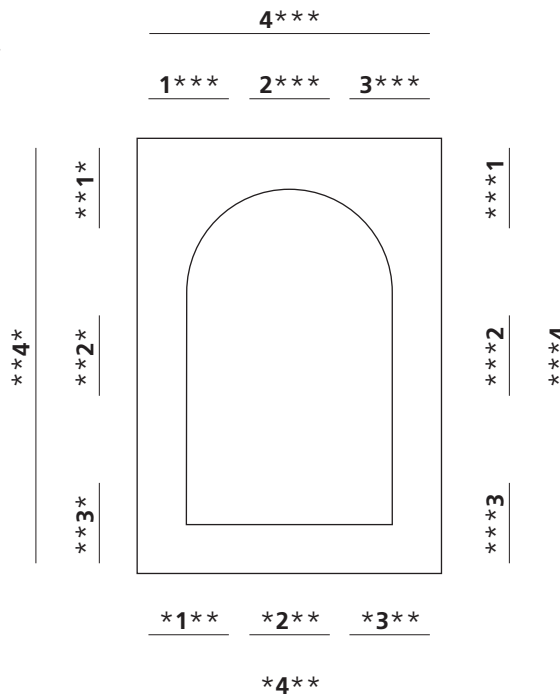

4***	Top full length
*4**	Bottom full length
**4*	Left side full length
***4	Right side full length
1***	Top left
2***	Top centre
3***	Top right
*1**	Bottom left
*2**	Bottom centre
*3**	Bottom right
**1*	Left side top
**2*	Left side centre
**3*	Left side bottom
***1	Right side top
***2	Right side centre
***3	Right side bottom

Quantity and Location of Hinges

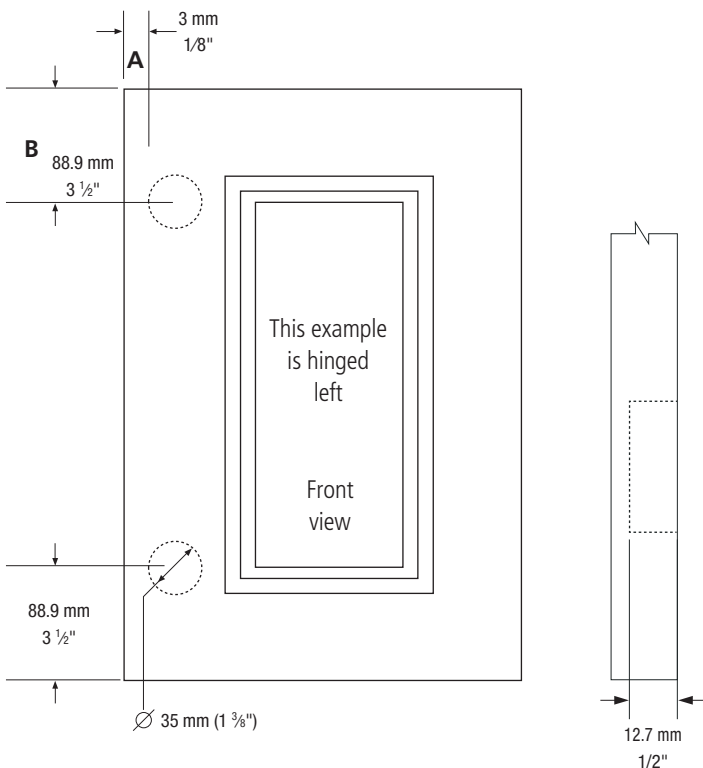

Standard hinge hole diameter: 35 mm (1 3/8")

Standard depth: 12.7 mm (1/2")

Standard location:

- for doors 254 mm (10") and over, 3 mm (1/8") from side and centred at 88.9 mm (3 1/2") from top or bottom edge of the door.
- for doors less than 254 mm (10"), 3 mm (1/8") from side and centred at 63.5 mm (2 1/2") from top or bottom edge of the door.

Note

For doors requiring more than 2 hinges, a drawing indicating actual position of the hinge holes is required.

Door height mm	Door height inches	Number of hinges required
0 to 899.16	0 to 35.4	2
899.17 to 1000.8	35.5 to 39.4	3
1000.9 to 1991.4	39.5 to 78.4	4
1991.5 to 2438.4	78.5 to 96	5

Minimum sizes indicated for each door model must be respected due to hinge clearance considerations.

CERTIFICATE OF
WARRANTY

10 YEARS

APPLICABLE TO THERMOPLASTIC PRODUCTS
Starting on January 1st 2011 (see conditions on reverse)

Distributor

Invoice #

Date of purchase



CERTIFICATE OF WARRANTY

1. General Terms and Conditions

Prémoulé guarantees its thermoplastic products which are distributed and sold through an authorized distributor.

The installation should only be done by an experienced professional. It is also the responsibility of the person installing the product to determine its suitability for a particular application.

Prémoulé guarantees its products against yellowing, delamination or any apparent or hidden defect that might affect their quality or cause premature deterioration. The following conditions apply:

2. Duration

This guarantee is valid for a period of 10 years following the date of purchase.

3. Exclusions

This guarantee does not apply:

3.1 When damages are caused:

- by misuse or abuse of the product by the buyer
- by improper installation or exposure to the elements
- by any modification, transformation, or correction of the product without a written authorization from Prémoulé;
- by improper storage;
- by any indirect damage (including incidentals, special or consequential damages);
- by exposure to a temperature over 85 °C (185 °F)

3.2 To any deterioration of the product resulting from normal wear and tear.

3.3 To any damage or incident relating to the costs of installation and transportation, or any other costs relative to the application of this guarantee.

4. Scope

This guarantee is unassignable and constitutes the only guarantee offered by Prémoulé.

There is no guarantee of merchantability or fitness for specific purposes other than the guarantee detailed above. Prémoulé makes no other guarantee whatsoever, expressed or implied, oral or written.

5. Execution of Guarantee

For the duration of this guarantee, in order to exercise his rights, the buyer shall notify as soon as possible the authorized distributor or PRÉMOULÉ of any defect in the product and shall provide proof of purchase or the back of this present certificate properly completed. The buyer shall not make any repairs before the authorized distributor has had an opportunity to examine the product and its installation.

When this guarantee is applicable, Prémoulé may repair its products, provide replacement products or, at its sole option, offer the reimbursement of the purchase price.

6. Authorized Distributor

Only an authorized Prémoulé distributor may, in compliance with the terms and conditions of this guarantee, assume the obligations contained herein after obtaining prior authorization from Prémoulé. The authorized distributor is not mandated by Prémoulé to modify or extend the scope of this guarantee.



2375, avenue Dalton, bureau 200
Québec (Québec) G1P 3S3

T 418 652-7777 | 1 866 652-7777
F 418 878-5591 | 1 866 878-5591

info@premoule.com

premoule.com

Photography in this leaflet is for illustration purposes only.
Actual color may vary slightly due to the printing process.
For accurate color selection we recommend that you obtain
a product sample.

2151-Q - VT00 - Suede Stone

Prémoulé supports

